

<b>1125</b>	<b>POLES, HARDWARE, AND FRAMING</b> <b>3PH XARM FRAMING 8FT</b>	
Sheet 1 of 1		
Rev: 09/13/20		

# 1125

## 3 PH XARM FRAMING 8FT

### CONTAINS

- 1125-02    3PH - XARM TANGENT/ANGLE SGL 8FT**
- 1125-05    3PH - XARM TANGENT/ANGLE DBL 8FT**
- 1125-21    3PH - XARM SINGLE DEAD END 8 FT**
- 1125-25    3PH - XARM DBL DE/SLACK SPAN 8 FT**
- 1125-32    3PH - XARM JUNCTION 8 FT**
- 1125-42    3PH - XARM SGL DE CORNER POLE 8 FT**
- 1125-61    3PH - SINGLE ALLEY ARM 8 FT**
- 1125-65    3PH - DBL ALLEY ARM 8 FT**

<b>1125-02</b>
Sheet 1 of 3
Rev: 09/13/20

**POLES, HARDWARE, AND FRAMING**  
**3PH XARM FRAMING 8FT**  
**3PH XARM TANGENT/ANGLE SGL 8 FT**

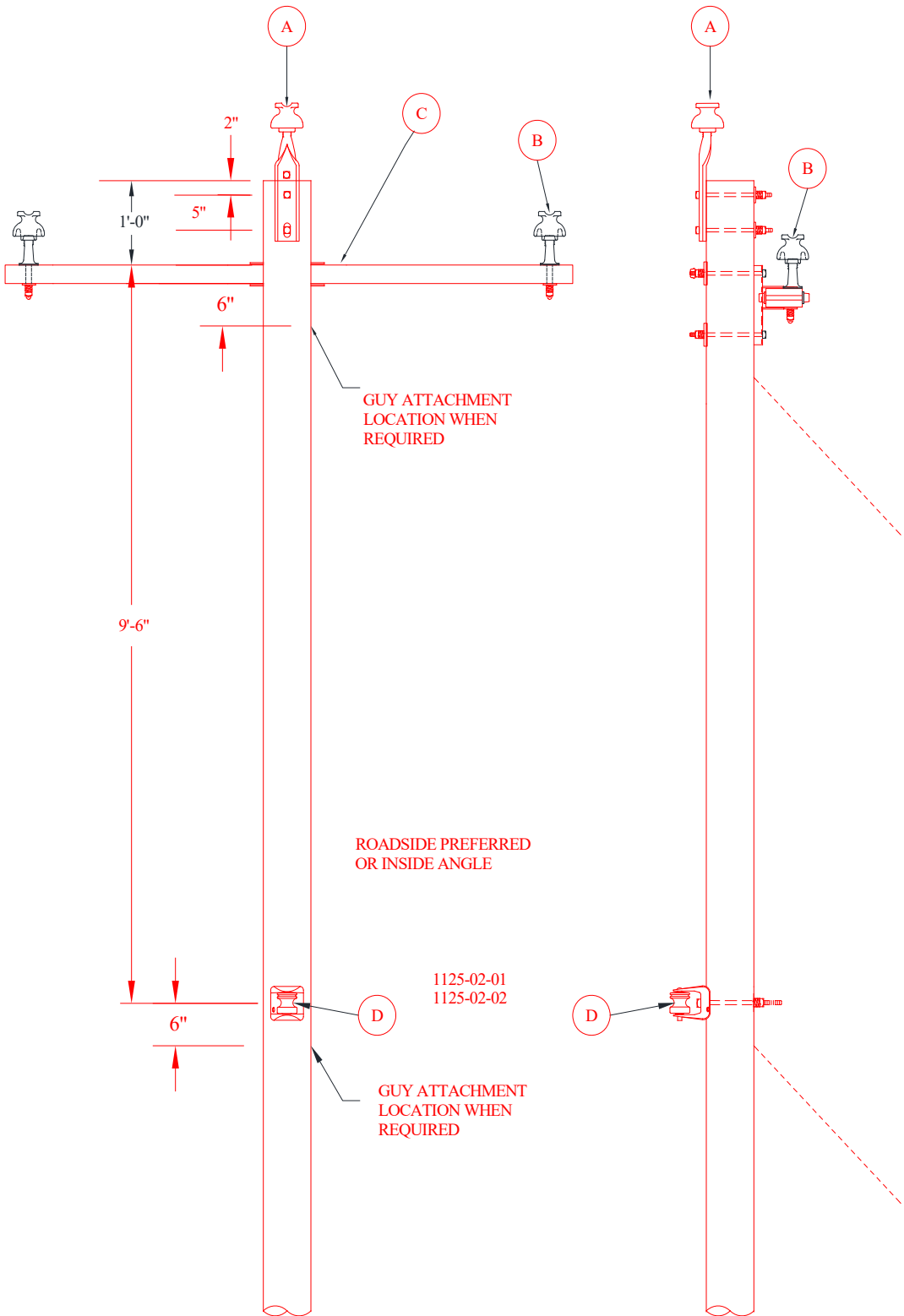

1125-02	<b>POLES, HARDWARE, AND FRAMING</b> <b>3PH XARM FRAMING 8FT</b> <b>3PH XARM TANGENT/ANGLE SGL 8 FT</b>	
Sheet 2 of 3		
Rev: 09/13/20		

**MU**

**REFERENCE FOR SPAN LENGTH/ANGLE PARAMETERS**

MU-REF	WIRE	PARAMETERS
1125-02-01	1/0	SPAN LENGTH < 300 FT
	4/0	SPAN LENGTH < 250 FT
	795	SPAN LENGTH < 250 FT
1125-02-02	1/0	ANGLE POLE < 30 DEGREES WITH SPAN LENGTH < 300 FT.
	4/0	ANGLE POLE < 09 DEGREES WITH SPAN LENGTH < 250 FT.
	795	ANGLE POLE < 09 DEGREES WITH SPAN LENGTH < 250 FT.

**MU-ID**

**MU-REF**

**MU-DESCRIPTION**

3PHXRTANSGLPNSGLNU8FT

11250201

3PH XARM TAN SGL PIN SGL NU 8FT

ID	CU-REF	CU-DESC	QTY	MU-REF
A	11200601	INSULATOR W/POLE TOP PIN SGL-TANGENT	1	11250201
B	11200802	INSULATOR W/LONG SHANK PIN	2	11250201
C	11201506	ARM FIBERGLASS LD SGL 8 FT	1	11250201
D	11201003	BRKT RACK 1 POINT 14 IN-SGL	1	11250201

3PHXRANGSGLPNSGLNU8FT

11250202

3PH XARM ANG SGL PIN SGL NU 8FT

ID	CU-REF	CU-DESC	QTY	MU-REF
A	11200603	INSULATOR W/POLE TOP PIN SGL- ANGLE	1	11250202
B	11200802	INSULATOR W/LONG SHANK PIN	2	11250202
C	11201506	ARM FIBERGLASS LD SGL 8 FT	1	11250202
D	11201003	BRKT RACK 1 POINT 14 IN-SGL	1	11250202

**NOTE ADD MODULE 11201003 WHEN SECOND BRACKET IS REQUIRED FOR SECONDARY SERVICE**

**ASSOCIATED MODULES**

	CU-REF	CU-DESCRIPTION	QTY	MU-REF
1/0-1/0	1240-04-03	TIES PREFM SGL 1/0	3	1125-02-01
	1240-05-40	TIES PREFM SIDE 1/0 NEUTRAL	1	1125-02-01
	1119-10-01	GRD WOOD POLE W/BUTT COIL #6-1/0N	1	1125-02-01
	1240-05-03	TIES PREFM SIDE SGL 1/0	3	1125-02-02
	1240-05-40	TIES PREFM SIDE 1/0 NEUTRAL	1	1125-02-02
	1119-10-01	GRD WOOD POLE W/BUTT COIL #6-1/0N	1	1125-02-02
	1163-12-10	DG DBL 2-3/8" GW W/ROD	1	1125-02-02

<b>1125-02</b>	<b>POLES, HARDWARE, AND FRAMING</b> <b>3PH XARM FRAMING 8FT</b> <b>3PH XARM TANGENT/ANGLE SGL 8 FT</b>	
Sheet 3 of 3		
Rev: 09/13/20		

	CU-REF	CU-DESCRIPTION	QTY	MU-REF
4/0-4/0	1240-04-06	TIES PREFM SINGL 4/0	3	1125-02-01
	1240-05-50	TIES PREFM SIDE 4/0 NEUTRAL	1	1125-02-01
	1119-10-02	GRD WOOD POLE W/BUTT COIL #6-4/0N	1	1125-02-01
	1240-05-06	TIES PREFM SIDE SGL 4/0	3	1125-02-02
	1240-05-50	TIES PREFM SIDE 4/0 NEUTRAL	1	1125-02-02
	1119-10-02	GRD WOOD POLE W/BUTT COIL #6-4/0N	1	1125-02-02
	1163-12-20	DG DBL 1-7/16" W/ROD AND 1-3/8" GW	1	1125-02-02

	CU-REF	CU-DESCRIPTION	QTY	MU-REF
795-4/0	1240-04-10	TIES PREFM SGL 795	3	1125-02-01
	1240-05-50	TIES PREFM SIDE 4/0 NEUTRAL	1	1125-02-01
	1119-10-02	GRD WOOD POLE W/BUTT COIL #6-4/0N	1	1125-02-01
	1240-05-10	TIES PREFM SIDE SGL 795	3	1125-02-02
	1240-05-50	TIES PREFM SIDE 4/0 NEUTRAL	1	1125-02-02
	1119-10-02	GRD WOOD POLE W/BUTT COIL #6-4/0N	1	1125-02-02
	1163-12-20	DG DBL 1-7/16" W/ROD AND 1-3/8" GW	1	1125-02-02

<b>1125-05</b>
Sheet 1 of 3
Rev: 09/13/20

**POLES, HARDWARE, AND FRAMING**  
**3PH XARM FRAMING 8FT**  
**3PH XARM TANGENT/ANGLE DBL 8 FT**

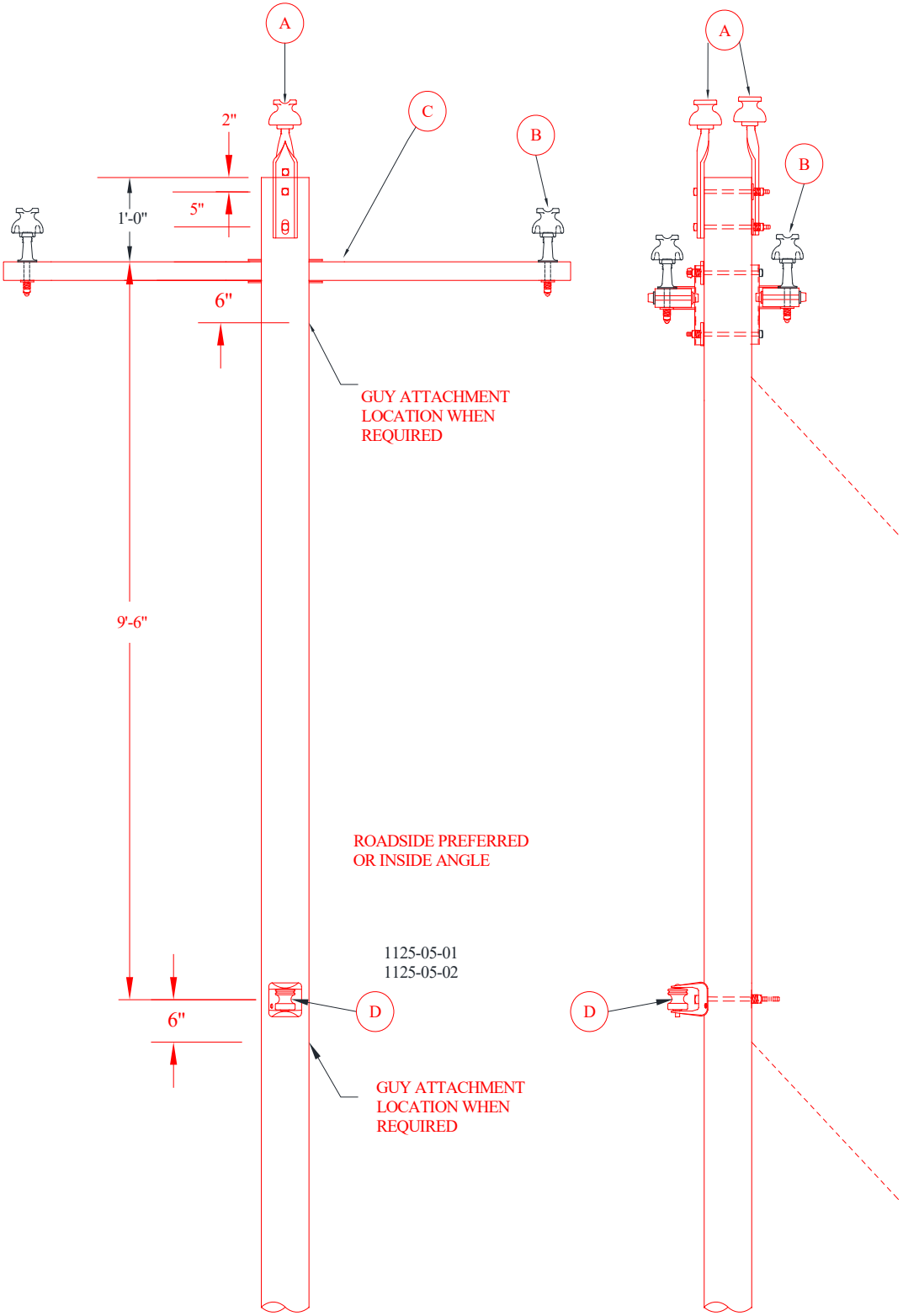

1125-05	<b>POLES, HARDWARE, AND FRAMING</b> <b>3PH XARM FRAMING 8FT</b> <b>3PH XARM TANGENT/ANGLE DBL 8 FT</b>	
Sheet 2 of 3		
Rev: 09/13/20		

**MU**

**REFERENCE FOR SPAN LENGTH/ANGLE PARAMETERS**

MU-REF	WIRE	PARAMETERS
1125-05-01	1/0	SPAN LENGTH > 300 FT
	4/0	SPAN LENGTH > 250 FT
	795	SPAN LENGTH > 250 FT
1125-05-02	1/0	ANGLE POLE < 30 DEGREES WITH SPAN LENGTH > 300 FT.
	4/0	ANGLE POLE > 09 AND < 18 DEGREES WITH SPAN LENGTH > 250 FT.
	795	ANGLE POLE > 09 AND < 18 DEGREES WITH SPAN LENGTH > 250 FT.

**MU-ID**

**MU-REF**

**MU-DESCRIPTION**

3PHXRTANDBLPNSGLNU8FT      11250501      3PH XARM TAN DBL PIN SGL NU 8FT

ID	CU-REF	CU-DESC	QTY	MU-REF
A	11200602	INSULATOR W/POLE TOP PIN DBL-TANGENT	1	11250501
B	11200802	INSULATOR W/LONG SHANK PIN	4	11250501
C	11201507	ARM FIBERGLASS LD DBL 8 FT	1	11250501
D	11201003	BRKT RACK 1 POINT 14 IN-SGL	1	11250501

3PHXRANGDBLPNSGLNU8FT      11250502      3PH XARM ANG DBL PIN SGL NU 8FT

ID	CU-REF	CU-DESC	QTY	MU-REF
A	11200604	INSULATOR W/POLE TOP PIN DBL- ANGLE	1	11250502
B	11200802	INSULATOR W/LONG SHANK PIN	4	11250502
C	11201507	ARM FIBERGLASS LD DBL 8 FT	1	11250502
D	11201003	BRKT RACK 1 POINT 14 IN-SGL	1	11250502

**NOTE ADD MODULE 11201003 WHEN SECOND BRACKET IS REQUIRED FOR SECONDARY SERVICE**

**ASSOCIATED MODULES**

	CU-REF	CU-DESCRIPTION	QTY	MU-REF
1/0-1/0	1240-04-23	TIES PREFM DBL 1/0	3	1125-05-01
	1240-05-40	TIES PREFM SIDE 1/0 NEUTRAL	1	1125-05-01
	1119-10-01	GRD WOOD POLE W/BUTT COIL #6-1/0N	1	1125-05-01
	1240-05-23	TIES PREFM SIDE DBL 1/0	3	1125-05-02
	1240-05-40	TIES PREFM SIDE 1/0 NEUTRAL	1	1125-05-02
	1119-10-01	GRD WOOD POLE W/BUTT COIL #6-1/0N	1	1125-05-02
	1163-12-10	DG DBL 2-3/8" GW W/ROD	1	1125-05-02

<b>1125-05</b>	<b>POLES, HARDWARE, AND FRAMING</b> <b>3PH XARM FRAMING 8FT</b> <b>3PH XARM TANGENT/ANGLE DBL 8 FT</b>	
Sheet 3 of 3		
Rev: 09/13/20		

	CU-REF	CU-DESCRIPTION	QTY	MU-REF
4/0-4/0	1240-04-26	TIES PREFM DBL 4/0	3	1125-05-01
	1240-05-50	TIES PREFM SIDE 4/0 NEUTRAL	1	1125-05-01
	1119-10-02	GRD WOOD POLE W/BUTT COIL #6-4/0N	1	1125-05-01
	1240-05-26	TIES PREFM SIDE DBL 4/0	3	1125-05-02
	1240-05-50	TIES PREFM SIDE 4/0 NEUTRAL	1	1125-05-02
	1119-10-02	GRD WOOD POLE W/BUTT COIL #6-4/0N	1	1125-05-02
	1163-12-20	DG DBL 1-7/16" W/ROD AND 1-3/8" GW	1	1125-05-02

	CU-REF	CU-DESCRIPTION	QTY	MU-REF
795-4/0	1240-04-30	TIES PREFM DBL 795	3	1125-05-01
	1240-05-50	TIES PREFM SIDE 4/0 NEUTRAL	1	1125-05-01
	1119-10-02	GRD WOOD POLE W/BUTT COIL #6-4/0N	1	1125-05-01
	1240-05-30	TIES PREFM SIDE DBL 795	3	1125-05-02
	1240-05-50	TIES PREFM SIDE 4/0 NEUTRAL	1	1125-05-02
	1119-10-02	GRD WOOD POLE W/BUTT COIL #6-4/0N	1	1125-05-02
	1163-12-20	DG DBL 1-7/16" W/ROD AND 1-3/8" GW	1	1125-05-02

<b>1125-21</b>
Sheet 1 of 2
Rev: 09/13/20

**POLES, HARDWARE, AND FRAMING**

**3PH XARM FRAMING 8FT**

**3PH XARM SINGLE DEAD END 8 FT**

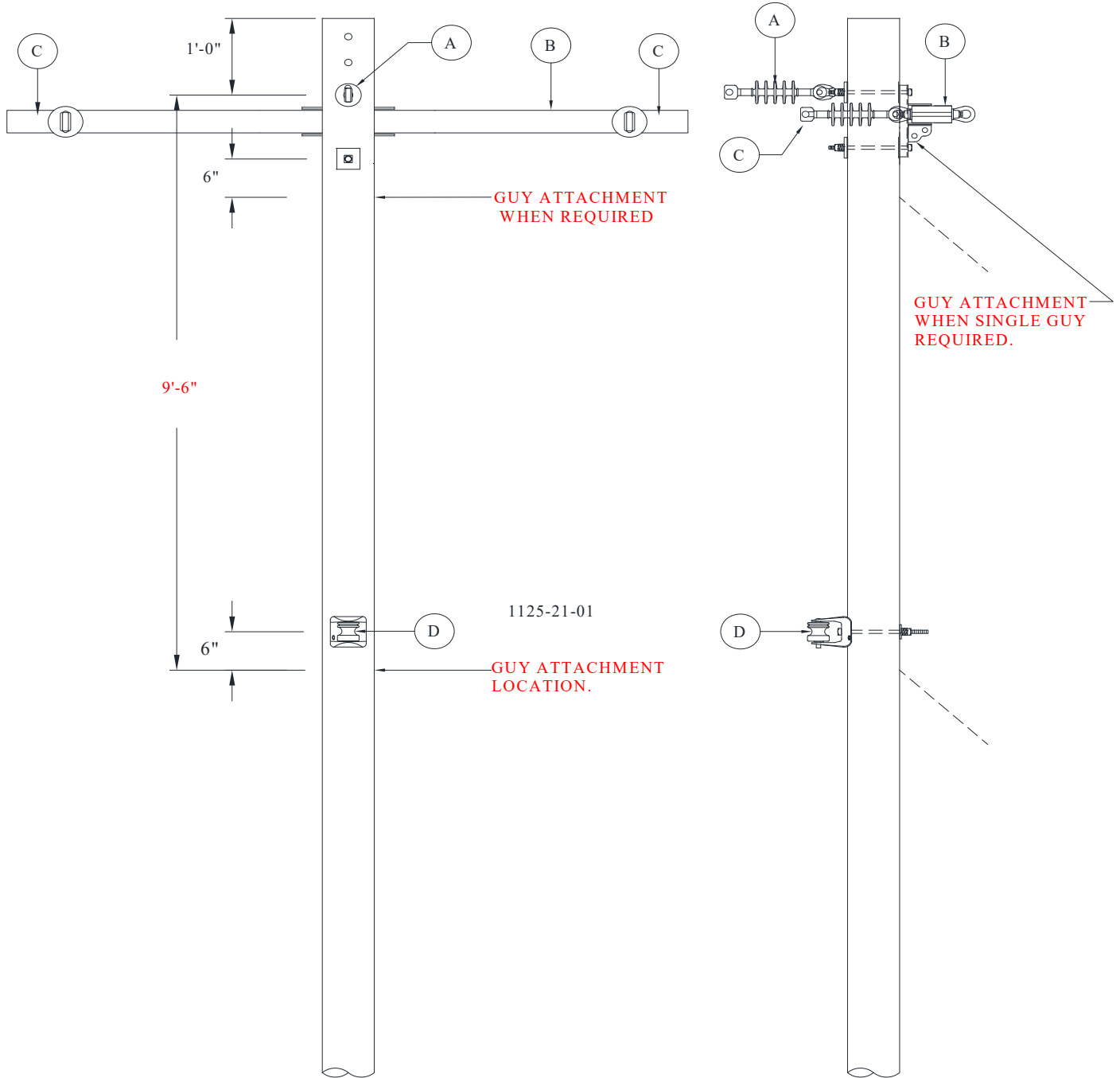







<b>1125-25</b>
Sheet 1 of 4
Rev: 09/13/20

**POLES, HARDWARE, AND FRAMING**

**3PH XARM FRAMING 8FT**

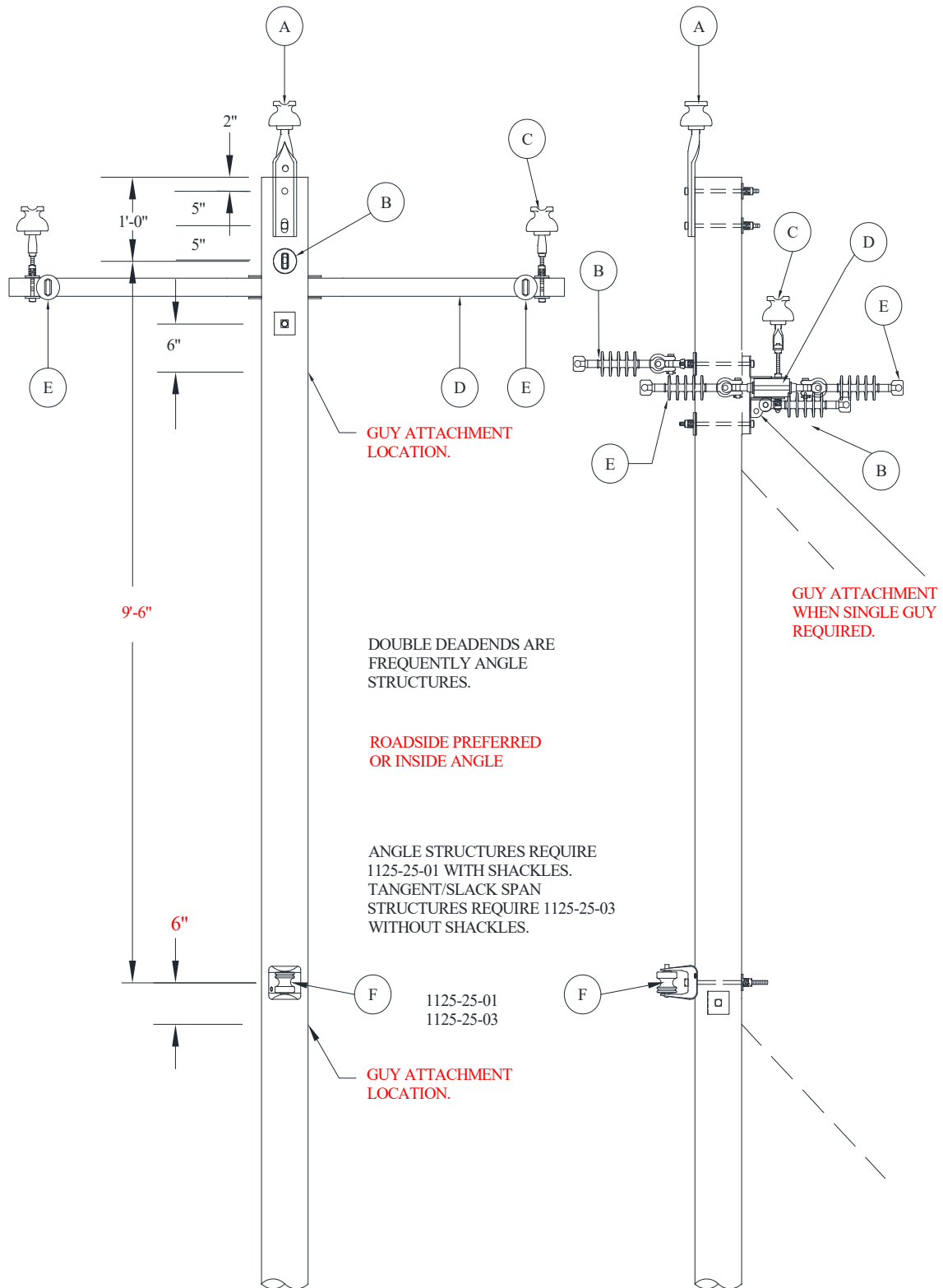
**3PH XARM DBL DE/SLACK SPAN 8 FT**



<b>1125-25</b>	<b>POLES, HARDWARE, AND FRAMING</b> <b>3PH XARM FRAMING 8FT</b> <b>3PH XARM DBL DE/SLACK SPAN 8 FT</b>	
Sheet 2 of 4		
Rev: 09/13/20		

**MU**

**REFERENCE FOR SPAN LENGTH/ANGLE PARAMETERS**

MU-REF	WIRE	PARAMETERS
1125-25-01	1/0	ANGLE POLE > 30 DEGREES AND < 60 DEGREES
	4/0	ANGLE POLE > 18 DEGREES AND < 30 DEGREES
	795	ANGLE POLE > 18 DEGREES AND < 30 DEGREES
1125-25-03	1/0	FULL TENSION DEADEND W/REDUCED TENSION SPAN
	4/0	FULL TENSION DEADEND W/REDUCED TENSION SPAN
	795	FULL TENSION DEADEND W/REDUCED TENSION SPAN

**MU-ID**

**MU-REF**

**MU-DESCRIPTION**

3PHXRDDDEHD8FT

11252501

3PH XARM DBL DE ANGLE HD 8FT

ID	CU-REF	CU-DESC	QTY	MU-REF
A	11200601	INSULATOR W/POLE TOP PIN SGL-TANGENT	1	11252501
B	11201707	INSULATOR DE SGL W/3/4" EYEBOLT	1	11252501
C	11201704	INSULATOR DE SGL W/3/4" EYENUT	1	11252501
D	11201611	ARM FIBERGLASS DE HD 8 FT	1	11252501
E	11201701	INSULATOR DE SGL	4	11252501
F	11200901	INSULATOR W/ADAPTOR PIN	2	11252501
G	11201009	BRKT RACK 1 POINT 14 IN-DBL	1	11252501

3PHXRDDERTNHD8FT

11252503

3PH XARM DBL DE REDUCED TENSION HD 8FT

ID	CU-REF	CU-DESC	QTY	MU-REF
A	11200601	INSULATOR W/POLE TOP PIN SGL-TANGENT	1	11252503
B	11201707	INSULATOR DE SGL W/3/4" EYEBOLT	1	11252503
C	11201704	INSULATOR DE SGL W/3/4" EYENUT	1	11252503
D	11201611	ARM FIBERGLASS DE HD 8 FT	1	11252503
E	11201701	INSULATOR DE SGL	4	11252503
F	11200901	INSULATOR W/ADAPTOR PIN	2	11252503
G	11201003	BRKT RACK 1 POINT 14 IN-SGL	2	11252503

**NOTE ADD MODULE 11201003 WHEN SECOND BRACKET IS REQUIRED FOR SECONDARY SERVICE**

**ASSOCIATED MODULES-**

	CU-REF	CU-DESCRIPTION	QTY	MU-REF
1/0-1/0	1240-01-01	DEAD END CLAMP 1/0-4/0	6	ALL GROUPS
	1240-04-03	TIES PREFM SGL 1/0	3	ALL GROUPS
	1240-03-11	DEAD END PREFM 1/0 ACSR	2	ALL GROUPS
	1119-10-01	GRD WOOD POLE W/BUTT COIL #6-1/0N	1	ALL GROUPS
	1163-12-10	DG DBL 2-3/8" GW W/ROD	1	ALL GROUPS
	1245-02-04	H-TAP CU/AL 1/0-1/0	8	ALL GROUPS

<b>1125-25</b>	<b>POLES, HARDWARE, AND FRAMING</b> <b>3PH XARM FRAMING 8FT</b> <b>3PH XARM DBL DE/SLACK SPAN 8 FT</b>	
Sheet 3 of 4		
Rev: 09/13/20		

	<b>CU-REF</b>	<b>CU-DESCRIPTION</b>	<b>QTY</b>	<b>MU-REF</b>
4/0-4/0	1240-01-01	DEAD END CLAMP 1/0-4/0	6	ALL GROUPS
	1240-04-06	TIES PREFM SGL 4/0	3	ALL GROUPS
	1240-03-40	DEAD END PREFM 4/0 AAC/ACSR	2	ALL GROUPS
	1119-10-02	GRD WOOD POLE W/BUTT COIL #6-4/0N	1	ALL GROUPS
	1163-12-20	DG DBL 1-7/16" W/ROD AND 1-3/8" GW	1	ALL GROUPS
	1245-02-07	H-TAP CU/AL 4/0-4/0	8	ALL GROUPS

	<b>CU-REF</b>	<b>CU-DESCRIPTION</b>	<b>QTY</b>	<b>MU-REF</b>
795-4/0	1240-01-07	DEAD END CLAMP 795	6	ALL GROUPS
	1240-04-10	TIES PREFM SGL 795	3	ALL GROUPS
	1240-03-40	DEAD END PREFM 4/0 AAC/ACSR	2	ALL GROUPS
	1119-10-02	GRD WOOD POLE W/BUTT COIL #6-4/0N	1	ALL GROUPS
	1163-14-20	DG TPL 2-7/16" W/ROD AND 1-3/8" GW	1	ALL GROUPS
	1245-07-77	CLAMP 2-BOLT 795-795	6	ALL GROUPS
	1245-02-07	H-TAP CU/AL 4/0-4/0	2	ALL GROUPS

<b>1125-32</b>
Sheet 1 of 4
Rev: 09/13/20

**POLES, HARDWARE, AND FRAMING**

**3PH XARM FRAMING 8FT**

**3PH XARM JUNCTION 8 FT**

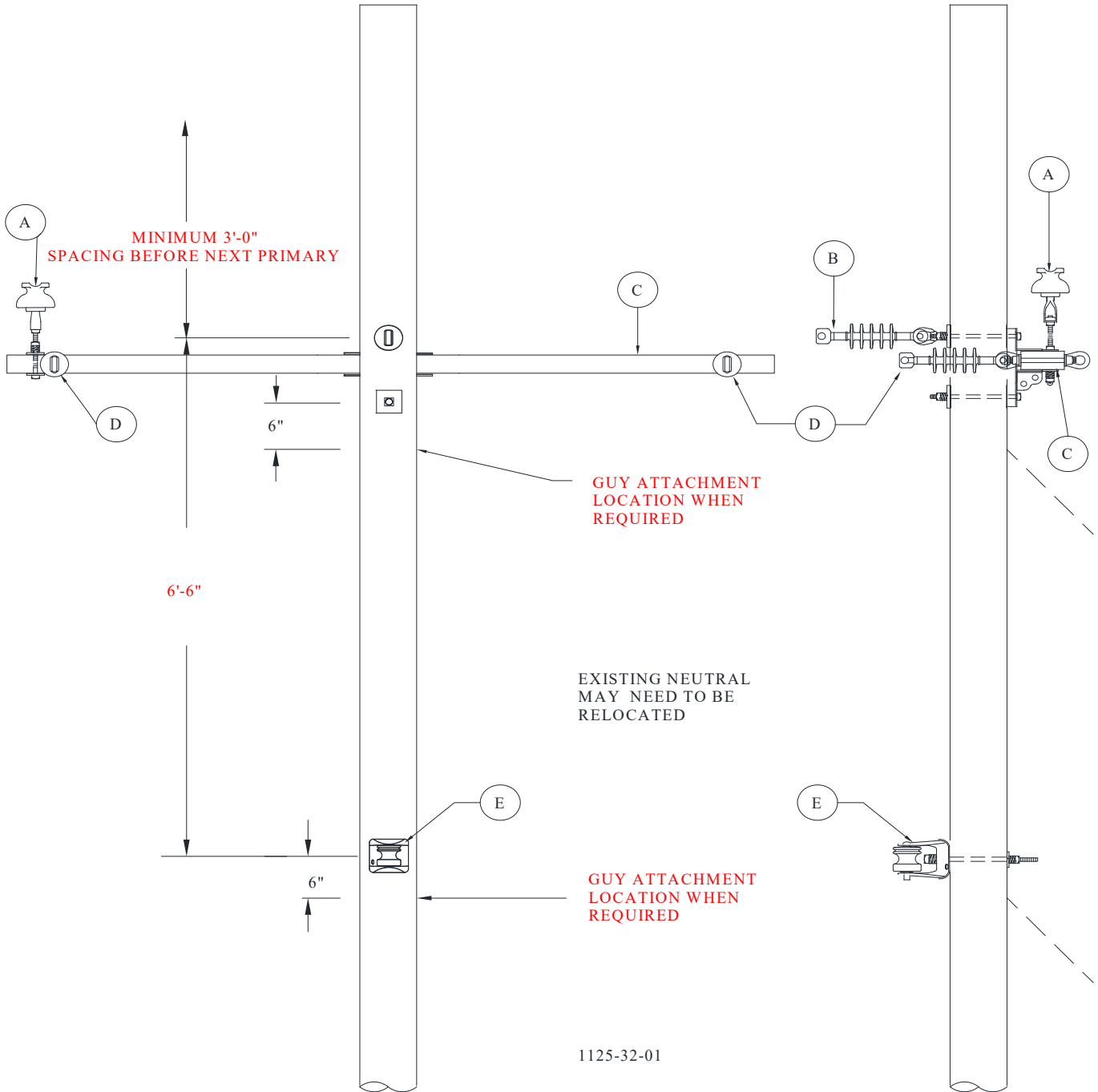

1125-32-01

1125-32	<b>POLES, HARDWARE, AND FRAMING</b> <b>3PH XARM FRAMING 8FT</b> <b>3PH XARM JUNCTION 8 FT</b>	
Sheet 2 of 4		
Rev: 09/13/20		

MU

**MU-ID MU-REF MU-DESCRIPTION**

3PHXRSDEJNH8FT 11253201 3PH XARM SGL DE JUNCT HD 8FT

ID	CU-REF	CU-DESC	QTY	MU-REF
A	11200901	INSULATOR W/ADAPTOR PIN	1	11253201
B	11201704	INSULATOR DE SGL W/3/4" EYENUT	1	11253201
C	11201611	ARM FIBERGLASS DE HD 8 FT	1	11253201
D	11201701	INSULATOR DE SGL	2	11253201
E	11201003	BRKT RACK 1 POINT 14 IN-SGL	1	11253201

**NOTE ADD MODULE 11201003 WHEN SECOND BRACKET IS REQUIRED FOR SECONDARY SERVICE**

**ASSOCIATED MODULES-FULL TENSION**

	CU-REF	CU-DESCRIPTION	QTY	MU-REF
1/0-1/0	1240-01-01	DEAD-END CLAMP 1/0-4/0	3	1125-32-01
	1240-03-11	DEAD END PREFM 1/0 ACSR	1	1125-32-01
	1163-12-10	DG DBL 2-3/8" GW W/ROD	1	1125-32-01

	CU-REF	CU-DESCRIPTION	QTY	MU-REF
4/0-4/0	1240-01-01	DEAD-END CLAMP 1/0-4/0	3	1125-32-01
	1240-03-40	DEAD END PREFM 4/0 AAC/ACSR	1	1125-32-01
	1163-12-20	DG DBL 1-7/16" W/ROD AND 1-3/8" GW	1	1125-32-01

	CU-REF	CU-DESCRIPTION	QTY	MU-REF
795-4/0	1240-01-07	DEAD-END CLAMP 795	3	1125-32-01
	1240-03-40	DEAD END PREFM 4/0 AAC/ACSR	1	1125-32-01
	1163-14-20	DG TPL 2-7/16" W/ROD AND 1-3/8" GW	1	1125-32-01

**ASSOCIATED MODULES-SLACK TENSION**

	CU-REF	CU-DESCRIPTION	QTY	MU-REF
1/0-1/0	1240-01-01	DEAD-END CLAMP 1/0-4/0	3	11253201
	1240-03-11	DEAD END PREFM 1/0 ACSR	1	11253201

	CU-REF	CU-DESCRIPTION	QTY	MU-REF
4/0-4/0	1240-01-01	DEAD-END CLAMP 1/0-4/0	3	11253201
	1240-03-40	DEAD END PREFM 4/0 AAC/ACSR	1	11253201

<b>1125-32</b>	<b>POLES, HARDWARE, AND FRAMING</b> <b>3PH XARM FRAMING 8FT</b> <b>3PH XARM JUNCTION 8 FT</b>	
Sheet 3 of 4		
Rev: 09/13/20		

	CU-REF	CU-DESCRIPTION	QTY	MU-REF
795-4/0	1240-01-07	DEAD-END CLAMP 795	3	11253201
	1240-03-40	DEAD END PREFM 4/0 AAC/ACSR	1	11253201

**ASSOCIATED MODULES-SOLID JUMPERS**

	CU-REF	CU-DESCRIPTION	QTY	MU-REF
1/0-1/0	1245-02-04	H-TAP CU/AL 1/0-1/0	7	1125-32-01
	1240-04-03	TIES PREFM SGL 1/0	1	1125-32-01

	CU-REF	CU-DESCRIPTION	QTY	MU-REF
4/0-4/0	1245-02-07	H-TAP CU/AL 4/0-4/0	7	1125-32-01
	1240-04-06	TIES PREFM SGL 4/0	1	1125-32-01

	CU-REF	CU-DESCRIPTION	QTY	MU-REF
4/0-795	1245-07-85	CLAMP 1-BOLT CU/AL 795-336	6	1125-32-01
	1240-04-06	TIES PREFM SGL 4/0	1	1125-32-01
	1245-02-07	H-TAP CU/AL 4/0-4/0	1	1125-32-01

	CU-REF	CU-DESCRIPTION	QTY	MU-REF
795-795	1245-07-77	CLAMP 2-BOLT 795-795	6	1125-32-01
	1245-02-07	H-TAP CU/AL 4/0-4/0	1	1125-32-01
	1240-04-10	TIES PREFM SGL 795	1	1125-32-01

**ASSOCIATED MODULES-FUSED**

	CU-REF	CU-DESCRIPTION	QTY	MU-REF
1/0-1/0	1245-02-04	H-TAP CU/AL 1/0-1/0	1	1125-32-01
	1368-12-20	LINE FUSE ASSY 8-10' DE ARM 1/0 PRI	3	1125-32-01

	CU-REF	CU-DESCRIPTION	QTY	MU-REF
4/0-1/0	1245-02-06	H-TAP CU/AL 4/0-1/0	1	1125-32-01
	1368-12-21	LINE FUSE ASSY 8-10' DE ARM 4/0 PRI	3	1125-32-01

	CU-REF	CU-DESCRIPTION	QTY	MU-REF
795-1/0	1245-02-07	H-TAP CU/AL 4/0-4/0	1	1125-32-01
	1368-12-24	LINE FUSE ASSY 8-10' DE ARM 795 PRI	3	1125-32-01

<b>1125-32</b>	<b>POLES, HARDWARE, AND FRAMING</b> <b>3PH XARM FRAMING 8FT</b> <b>3PH XARM JUNCTION 8 FT</b>	
Sheet 4 of 4		
Rev: 09/13/20		

**ASSOCIATED MODULES-HOT TAP JUMPERS**

	<b>CU-REF</b>	<b>CU-DESCRIPTION</b>	<b>QTY</b>	<b>MU-REF</b>
1/0-1/0	1245-02-04	H-TAP CU/AL 1/0-1/0	1	1125-32-01
	1368-05-40	JUMPER ASSY-HOT TAP 1/0 AL PRI	3	1125-32-01



1125-42
Sheet 1 of 3
Rev: 09/13/20

**POLES, HARDWARE, AND FRAMING**  
**3PH XARM FRAMING 8FT**  
**3PH XARM SGL DE CORNER POLE 8 FT**

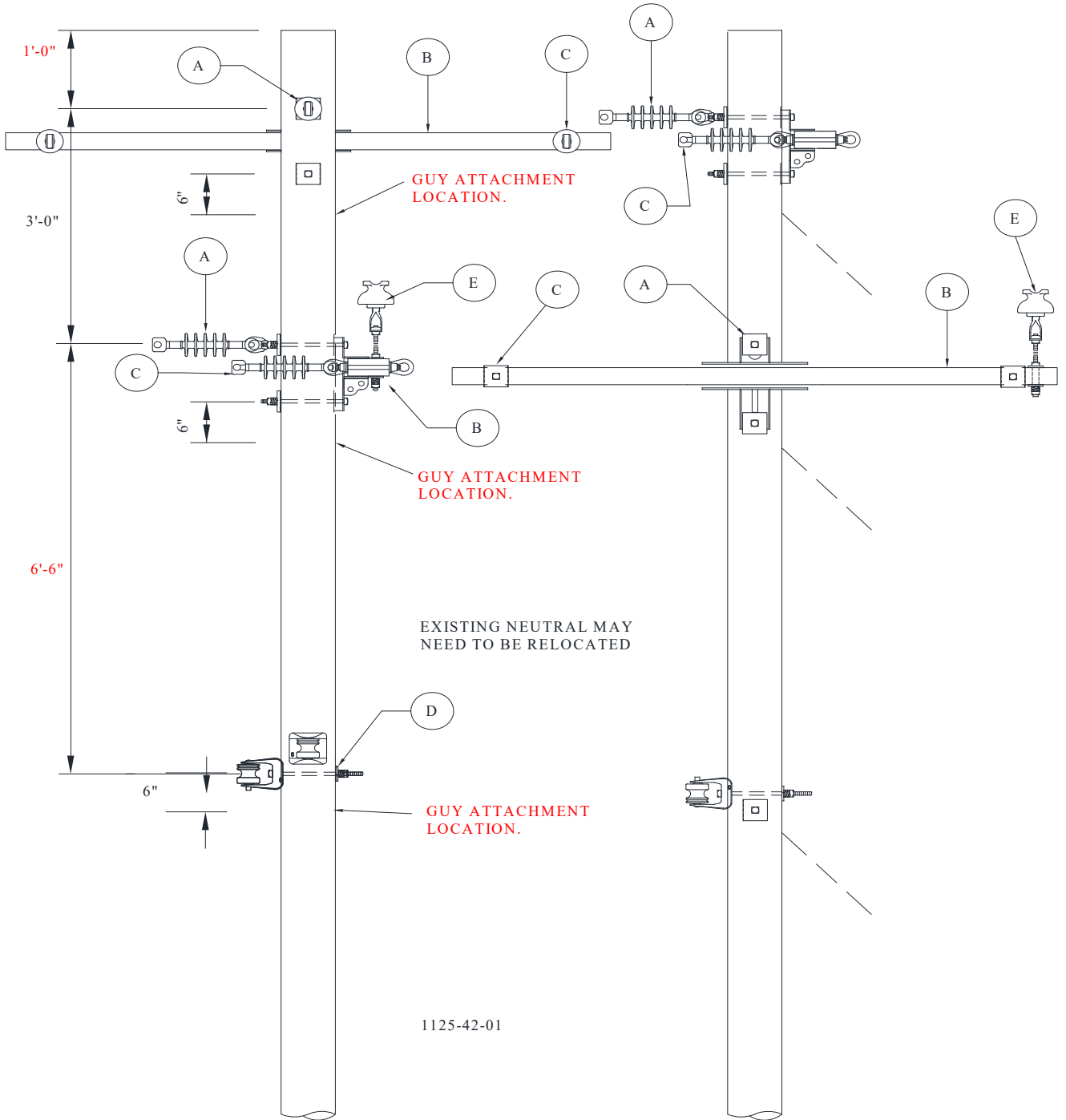

1125-42	POLES, HARDWARE, AND FRAMING	
Sheet 2 of 3	3PH XARM FRAMING 8FT	
Rev: 09/13/20	3PH XARM SGL DE CORNER POLE 8 FT	

MU

MU-ID MU-REF MU-DESCRIPTION

3PHXRSDECNHD8FT 11254201 3PH XARM SGL DE CORNER 8FT

ID	CU-REF	CU-DESC	QTY	MU-REF
A	11201704	INSULATOR DE SGL W/3/4" EYENUT	2	11254201
B	11201611	ARM FIBERGLASS DE HD 8 FT	2	11254201
C	11201701	INSULATOR DE SGL	4	11254201
D	11201003	BRKT RACK 1 POINT 14 IN-SGL	2	11254201
E	11200901	INSULATOR W/ADAPTOR PIN	1	11254201

**NOTE ADD MODULE 11201003 WHEN SECOND BRACKET IS REQUIRED FOR SECONDARY SERVICE**

**ASSOCIATED MODULES-FULL TENSION**

	CU-REF	CU-DESCRIPTION	QTY	MU-REF
1/0-1/0	1240-01-01	DEAD-END CLAMP 1/0-4/0	6	1125-42-01
	1119-10-01	GRD WOOD POLE W/BUTT COIL #6-1/0N	1	1125-42-01
	1163-12-10	DG DBL 2-3/8" GW W/ROD	2	1125-42-01
	1240-03-11	DEAD END PREFM 1/0 ACSR	2	1125-42-01
	1240-04-03	TIES PREFM SGL 1/0	1	1125-42-01
	1245-02-04	H-TAP CU/AL 1/0-1/0	7	1125-42-01

	CU-REF	CU-DESCRIPTION	QTY	MU-REF
4/0 -4/0	1240-01-01	DEAD-END CLAMP 1/0-4/0	6	1125-42-01
	1119-10-02	GRD WOOD POLE W/BUTT COIL #6-4/0N	1	1125-42-01
	1163-12-20	DG DBL 1-7/16" W/ROD AND 1-3/8" GW	2	1125-42-01
	1240-03-40	DEAD END PREFM 4/0 AAC/ACSR	2	1125-42-01
	1240-04-06	TIES PREFM SGL 4/0	1	1125-42-01
	1245-02-07	H-TAP CU/AL 4/0-4/0	7	1125-42-01

	CU-REF	CU-DESCRIPTION	QTY	MU-REF
795-4/0	1240-01-07	DEAD-END CLAMP 795	6	1125-42-01
	1119-10-02	GRD WOOD POLE W/BUTT COIL #6-4/0N	1	1125-42-01
	1163-14-20	DG TPL 2-7/16" W/ROD AND 1-3/8" GW	2	1125-42-01
	1240-03-40	DEAD END PREFM 4/0 AAC/ACSR	2	1125-42-01
	1245-07-77	CLAMP 2-BOLT 795-795	6	1125-42-01
	1240-04-10	TIES PREFM SGL 795	1	1125-42-01
	1245-02-07	H-TAP CU/AL 4/0-4/0	1	1125-42-01

<b>1125-42</b>	<b>POLES, HARDWARE, AND FRAMING</b> <b>3PH XARM FRAMING 8FT</b> <b>3PH XARM SGL DE CORNER POLE 8 FT</b>	
Sheet 3 of 3		
Rev: 09/13/20		

**ASSOCIATED MODULES-REDUCED TENSION**

	<b>CU-REF</b>	<b>CU-DESCRIPTION</b>	<b>QTY</b>	<b>MU-REF</b>
1/0-1/0	1240-01-01	DEAD-END CLAMP 1/0-4/0	6	1125-42-01
	1119-10-01	GRD WOOD POLE W/BUTT COIL #6-1/0N	1	1125-42-01
	1240-03-11	DEAD END PREFM 1/0 ACSR	2	1125-42-01
	1240-04-03	TIES PREFM SGL 1/0	1	1125-42-01
	1245-02-04	H-TAP CU/AL 1/0-1/0	7	1125-42-01

	<b>CU-REF</b>	<b>CU-DESCRIPTION</b>	<b>QTY</b>	<b>MU-REF</b>
4/0 -4/0	1240-01-01	DEAD-END CLAMP 1/0-4/0	6	1125-42-01
	1119-10-02	GRD WOOD POLE W/BUTT COIL #6-4/0N	1	1125-42-01
	1240-03-40	DEAD END PREFM 4/0 AAC/ACSR	2	1125-42-01
	1240-04-06	TIES PREFM SGL 4/0	1	1125-42-01
	1245-02-07	H-TAP CU/AL 4/0-4/0	7	1125-42-01

	<b>CU-REF</b>	<b>CU-DESCRIPTION</b>	<b>QTY</b>	<b>MU-REF</b>
795-4/0	1240-01-07	DEAD-END CLAMP 795	6	1125-42-01
	1119-10-02	GRD WOOD POLE W/BUTT COIL #6-4/0N	1	1125-42-01
	1240-03-40	DEAD END PREFM 4/0 AAC/ACSR	2	1125-42-01
	1240-04-10	TIES PREFM SGL 795	1	1125-42-01
	1245-07-77	CLAMP 2-BOLT 795-795	6	1125-42-01
	1245-02-07	H-TAP CU/AL 4/0-4/0	1	1125-42-01

<b>1125-61</b>
Sheet 1 of 3
Rev: 09/13/20

**POLES, HARDWARE, AND FRAMING**

**3PH XARM FRAMING 8FT**

**3PH SINGLE ALLEY ARM 8 FT**

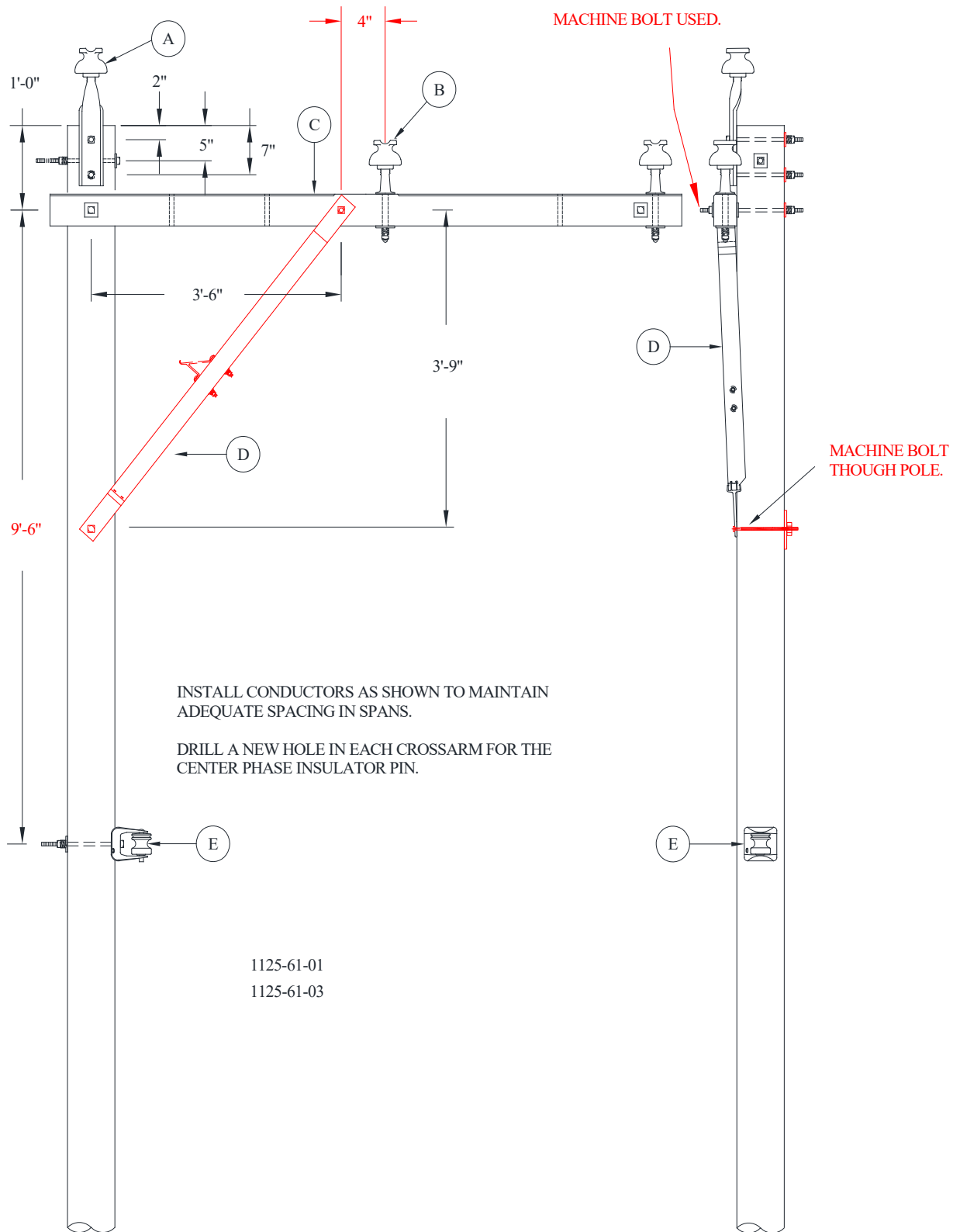

1125-61-01  
1125-61-03

<b>1125-61</b>	<b>POLES, HARDWARE, AND FRAMING 3PH XARM FRAMING 8FT 3PH SINGLE ALLEY ARM 8 FT</b>	
Sheet 2 of 3		
Rev: 09/13/20		

**MU**

**REFERENCE FOR SPAN LENGTH/ANGLE PARAMETERS**

MU-REF	WIRE	PARAMETERS
1125-61-01	1/0	SPAN LENGTH < 300 FT
	4/0	SPAN LENGTH < 250 FT
	795	SPAN LENGTH < 250 FT
1125-61-03	1/0	ANGLE POLE < 30 DEGREES WITH SPAN LENGTH < 300 FT.
	4/0	ANGLE POLE < 09 DEGREES WITH SPAN LENGTH < 250 FT.
	795	ANGLE POLE < 09 DEGREES WITH SPAN LENGTH < 250 FT.

**MU- ID MU- REF MU- DESCRIPTION**

3PHAATANSGLPNSGLNU8FT 11256101 3PH ALLEY ARM TAN SGL PIN SGL NU 8FT

ID	CU- REF	CU- DESC	QTY	MU- REF
A	11200601	INSULATOR W/POLE TOP PIN SGL- TANGENT	1	11256101
B	11200802	INSULATOR W/LONG SHANK PIN	2	11256101
C	11201501	ARM WOOD SGL LD 8 FT	1	11256101
D	11201401	WOOD BRACE 5 FT FOR SGL 8 FT ALLEY ARM	1	11256101
E	11201003	BRKT RACK 1 POINT 14 IN- SGL	1	11256101

3PHAAAANGSGLPNSGLNU8FT 11256103 3PH ALLEY ARM ANG SGL PIN SGL NU 8FT

ID	CU- REF	CU- DESC	QTY	MU- REF
A	11200603	INSULATOR W/POLE TOP PIN SGL- ANGLE	1	11256103
B	11200802	INSULATOR W/LONG SHANK PIN	2	11256103
C	11201501	ARM WOOD SGL LD 8 FT	1	11256103
D	11201401	WOOD BRACE 5 FT FOR SGL 8 FT ALLEY ARM	1	11256103
E	11201003	BRKT RACK 1 POINT 14 IN- SGL	1	11256103

**NOTE ADD MODULE 11201003 WHEN SECOND BRACKET IS REQUIRED FOR SECONDARY SERVICE**

**ASSOCIATED MODULES**

<b>1125-61</b>	<b>POLES, HARDWARE, AND FRAMING</b> <b>3PH XARM FRAMING 8FT</b> <b>3PH SINGLE ALLEY ARM 8 FT</b>	
Sheet 3 of 3		
Rev: 09/13/20		

	CU-REF	CU-DESCRIPTION	QTY	MU-REF
1/0-1/0	1240-04-03	TIES PREFM SGL 1/0	3	1125-61-01
	1240-05-40	TIES PREFM SIDE 1/0 NEUTRAL	1	1125-61-01
	1119-10-01	GRD WOOD POLE W/BUTT COIL #6-1/0N	1	1125-61-01
	1240-05-03	TIES PREFM SIDE SGL 1/0	3	1125-61-03
	1240-05-40	TIES PREFM SIDE 1/0 NEUTRAL	1	1125-61-03
	1119-10-01	GRD WOOD POLE W/BUTT COIL #6-1/0N	1	1125-61-03
	1163-12-10	DG DBL 2-3/8" GW W/ROD	1	1125-61-03

	CU-REF	CU-DESCRIPTION	QTY	MU-REF
4/0-4/0	1240-04-06	TIES PREFM SGL 4/0	3	1125-61-01
	1240-05-50	TIES PREFM SIDE 4/0 NEUTRAL	1	1125-61-01
	1119-10-02	GRD WOOD POLE W/BUTT COIL #6-4/0N	1	1125-61-01
	1240-05-06	TIES PREFM SIDE SGL 4/0	3	1125-61-03
	1240-05-50	TIES PREFM SIDE 4/0 NEUTRAL	1	1125-61-03
	1119-10-02	GRD WOOD POLE W/BUTT COIL #6-4/0N	1	1125-61-03
	1163-12-20	DG DBL 1-7/16" W/ROD AND 1-3/8" GW	1	1125-61-03

	CU-REF	CU-DESCRIPTION	QTY	MU-REF
795-4/0	1240-04-10	TIES PREFM SGL 795	3	1125-61-01
	1240-05-50	TIES PREFM SIDE 4/0 NEUTRAL	1	1125-61-01
	1119-10-02	GRD WOOD POLE W/BUTT COIL #6-4/0N	1	1125-61-01
	1240-05-10	TIES PREFM SIDE SGL 795	3	1125-61-03
	1240-05-50	TIES PREFM SIDE 4/0 NEUTRAL	1	1125-61-03
	1119-10-02	GRD WOOD POLE W/BUTT COIL #6-4/0N	1	1125-61-03
	1163-12-20	DG DBL 1-7/16" W/ROD AND 1-3/8" GW	1	1125-61-03

<b>1125-65</b>
Sheet 1 of 3
Rev: 09/13/20

**POLES, HARDWARE, AND FRAMING**

**3PH XARM FRAMING 8FT**

**3PH DBL ALLEY ARM 8 FT**

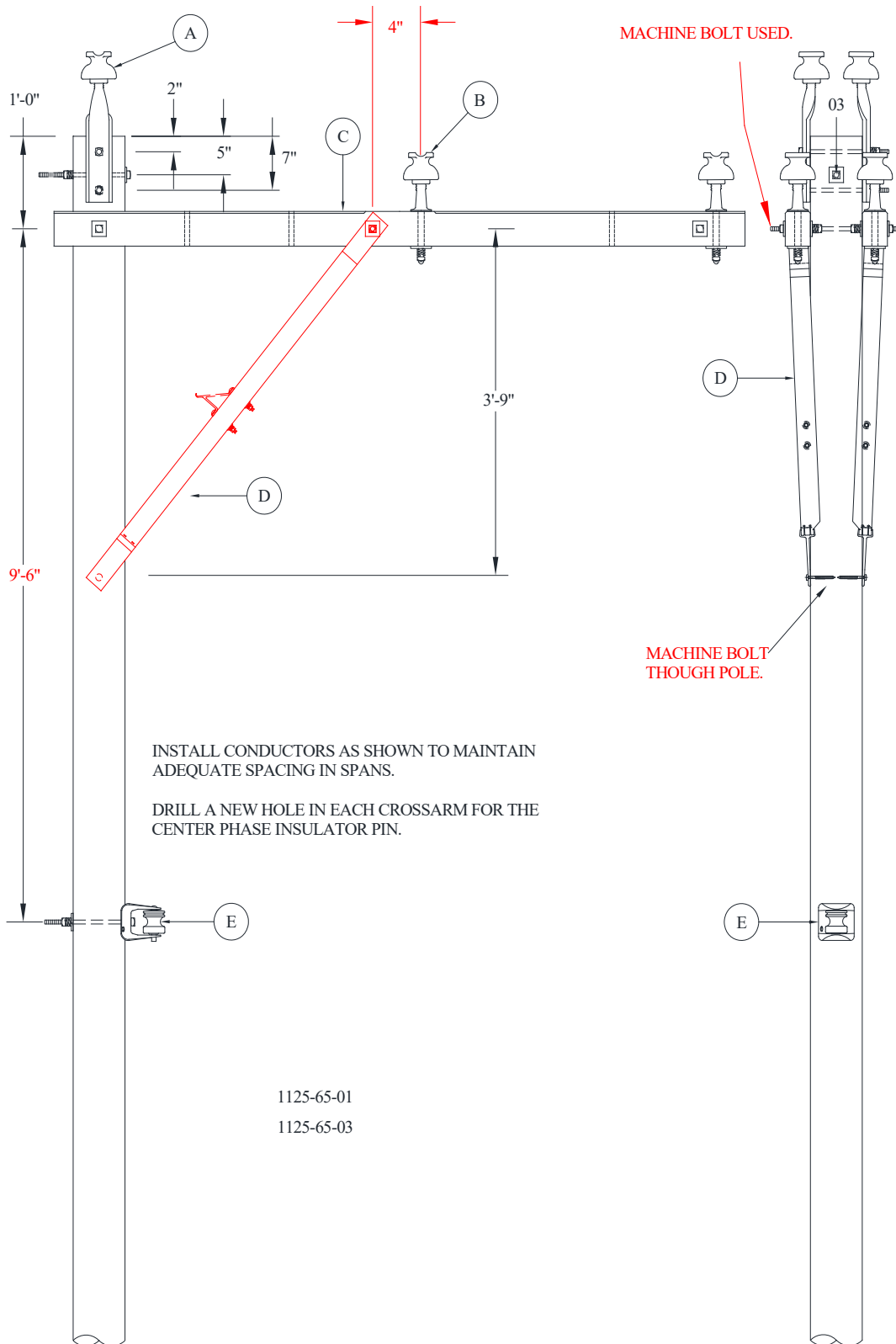

1125-65-01  
 1125-65-03

1125-65	<b>POLES, HARDWARE, AND FRAMING</b> <b>3PH XARM FRAMING 8FT</b> <b>3PH DBL ALLEY ARM 8 FT</b>	
Sheet 2 of 3		
Rev: 09/13/20		

**MU**

**REFERENCE FOR SPAN LENGTH/ANGLE PARAMETERS**

MU-REF	WIRE	PARAMETERS
1125-65-01	1/0	SPAN LENGTH > 300 FT
	4/0	SPAN LENGTH > 250 FT
	795	SPAN LENGTH > 250 FT
1125-65-03	1/0	ANGLE POLE < 30 DEGREES WITH SPAN LENGTH > 300 FT.
	4/0	ANGLE POLE > 09 AND < 18 DEGREES
	795	ANGLE POLE > 09 AND < 18 DEGREES

**MU-ID**

**MU-REF**

**MU-DESCRIPTION**

3PHAATANDBLPNSGLNU8FT

11256501

3PH ALLEY ARM TAN DBL PIN SGL NU 8FT

ID	CU-REF	CU-DESC	QTY	MU-REF
A	11200602	INSULATOR W/POLE TOP PIN DBL-TANGENT	1	11256501
B	11200802	INSULATOR W/LONG SHANK PIN	4	11256501
C	11201502	ARM WOOD DBL LD 8 FT	1	11256501
D	11201402	WOOD BRACE 5 FT FOR DBL 8 FT ALLEY ARM	1	11256501
E	11201003	BRKT RACK 1 POINT 14 IN-SGL	1	11256501

3PHAAANGDBLPNSGLNU8FT

11256503

3PH ALLEY ARM ANG DBL PIN SGL NU 8FT

ID	CU-REF	CU-DESC	QTY	MU-REF
A	11200604	INSULATOR W/POLE TOP PIN DBL- ANGLE	1	11256503
B	11200802	INSULATOR W/LONG SHANK PIN	4	11256503
C	11201502	ARM WOOD DBL LD 8 FT	1	11256503
D	11201402	WOOD BRACE 5 FT FOR DBL 8 FT ALLEY ARM	1	11256503
E	11201003	BRKT RACK 1 POINT 14 IN-SGL	1	11256503

**NOTE ADD MODULE 11201003 WHEN SECOND BRACKET IS REQUIRED FOR SECONDARY SERVICE**

**ASSOCIATED MODULES**



<b>1125-65</b>	<b>POLES, HARDWARE, AND FRAMING</b> <b>3PH XARM FRAMING 8FT</b> <b>3PH DBL ALLEY ARM 8 FT</b>	
Sheet 3 of 3		
Rev: 09/13/20		

	<b>CU-REF</b>	<b>CU-DESCRIPTION</b>	<b>QTY</b>	<b>MU-REF</b>
1/0-1/0	1240-04-23	TIES PREFM DBL 1/0	3	1125-65-01
	1240-05-40	TIES PREFM SIDE 1/0 NEUTRAL	1	1125-65-01
	1119-10-01	GRD WOOD POLE W/BUTT COIL #6-1/0N	1	1125-65-01
	1240-05-23	TIES PREFM SIDE DBL 1/0	3	1125-65-03
	1240-05-40	TIES PREFM SIDE 1/0 NEUTRAL	1	1125-65-03
	1119-10-01	GRD WOOD POLE W/BUTT COIL #6-1/0N	1	1125-65-03
	1163-12-10	DG DBL 2-3/8" GW W/ROD	1	1125-65-03

	<b>CU-REF</b>	<b>CU-DESCRIPTION</b>	<b>QTY</b>	<b>MU-REF</b>
795-4/0	1240-04-30	TIES PREFM DBL 795	3	1125-65-01
	1240-05-50	TIES PREFM SIDE 4/0 NEUTRAL	1	1125-65-01
	1119-10-02	GRD WOOD POLE W/BUTT COIL #6-4/0N	1	1125-65-01
	1240-05-30	TIES PREFM SIDE DBL 795	3	1125-65-03
	1240-05-50	TIES PREFM SIDE 4/0 NEUTRAL	1	1125-65-03
	1119-10-02	GRD WOOD POLE W/BUTT COIL #6-4/0N	1	1125-65-03
	1163-12-20	DG DBL 1-7/16" W/ROD AND 1-3/8" GW	1	1125-65-03

	<b>CU-REF</b>	<b>CU-DESCRIPTION</b>	<b>QTY</b>	<b>MU-REF</b>
4/0-4/0	1240-04-26	TIES PREFM DBL 4/0	3	1125-65-01
	1240-05-50	TIES PREFM SIDE 4/0 NEUTRAL	1	1125-65-01
	1119-10-02	GRD WOOD POLE W/BUTT COIL #6-4/0N	1	1125-65-01
	1240-05-26	TIES PREFM SIDE DBL 4/0	3	1125-65-03
	1240-05-50	TIES PREFM SIDE 4/0 NEUTRAL	1	1125-65-03
	1119-10-02	GRD WOOD POLE W/BUTT COIL #6-4/0N	1	1125-65-03
	1163-12-20	DG DBL 1-7/16" W/ROD AND 1-3/8" GW	1	1125-65-03