

1133	POLES, HARDWARE, AND FRAMING	 11/01
Sheet 1 of 1	3PH XARM FRAMING 10FT	
Rev 08/01/2020		

1133

3 PH XARM FRAMING 10FT

CONTAINS

- 1133-02 3PH - XARM TANGENT/ANGLE SGL 10 FT
- 1133-05 3PH - XARM TANGENT/ANGLE DBL 10 FT
- 1133-22 3PH - XARM SINGLE DEAD END HD 10 FT
- 1133-42 3PH - XARM SGL DE CORNER POLE 10 FT
- 1133-52 3PH - XARM DBL DEAD END 10 FT
- 1133-55 3PH - XARM JUNCTION 10 FT
- 1133-60 3PH - SINGLE ALLEY ARM 10 FT
- 1133-61 3PH - DBL ALLEY ARM 10 FT

1133-02
Sheet 1 of 3
Rev 08/01/2020

POLES, HARDWARE, AND FRAMING
3PH XARM FRAMING 10FT
3PH XARM TANGENT/ANGLE SINGLE 10 FT



11/01

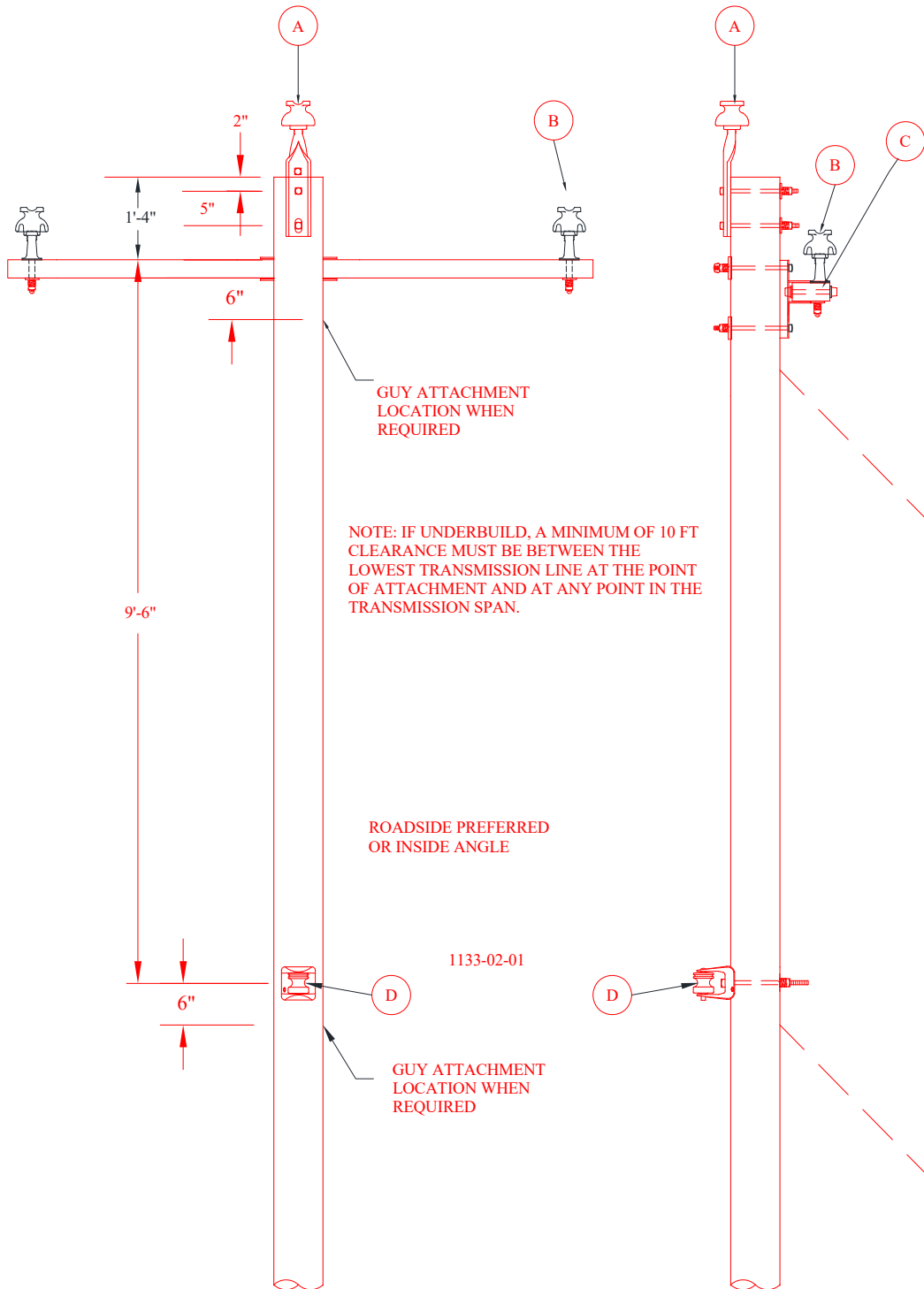

1133-02	POLES, HARDWARE, AND FRAMING 3PH XARM FRAMING 10FT 3PH XARM TANGENT/ANGLE SINGLE 10 FT	 11/01
Sheet 2 of 3		
Rev 08/01/2020		

MU

REFERENCE FOR SPAN LENGTH/ANGLE PARAMETERS

MU-REF	WIRE	PARAMETERS
1133-02-01	1/0	SPAN LENGTH < 300 FT
	4/0	SPAN LENGTH < 250 FT
	795	SPAN LENGTH < 250 FT
	1/0	ANGLE POLE < 30 DEGREES WITH SPAN LENGTH < 300 FT.
	4/0	ANGLE POLE < 09 DEGREES WITH SPAN LENGTH < 250 FT.
	795	ANGLE POLE < 09 DEGREES WITH SPAN LENGTH < 250 FT.

MU-ID	MU-REF	MU-DESCRIPTION
--------------	---------------	-----------------------

3PHXR TN/AGSGL PNSGL NU 10FT	11330201	3PH XARM TAN/ANG SGL PIN SGL NU 10FT
------------------------------	----------	--------------------------------------

ID	CU-REF	CU-DESC	QTY	MU-REF
B	11200802	INSULATOR W/LONG SHANK PIN	2	11330201
C	11201508	ARM FIBERGLASS LD SGL 10 FT	1	11330201
D	11201003	BRKT RACK 1 POINT 14 IN-SGL	1	11330201
A	11200701	INSULATOR W/FIBERGLASS POLE TOP PIN-SGL	1	11330201

NOTE ADD MODULE 11201003 WHEN SECOND BRACKET IS REQUIRED FOR SECONDARY SERVICE

ASSOCIATED MODULES

	CU-REF	CU-DESCRIPTION	QTY	MU-REF
1/0-1/0 TAN	1240-04-03	TIES PREFM SGL 1/0	3	1133-02-01
	1240-05-40	TIES PREFM SIDE 1/0 NEUTRAL	1	1133-02-01
	1119-10-01	GRD WOOD POLE W/BUTT COIL #6-1/0N	1	1133-02-01

	CU-REF	CU-DESCRIPTION	QTY	MU-REF
1/0-1/0 ANG	1240-05-03	TIES PREFM SIDE SGL 1/0	3	1133-02-01
	1240-05-40	TIES PREFM SIDE 1/0 NEUTRAL	1	1133-02-01
	1119-10-01	GRD WOOD POLE W/BUTT COIL #6-1/0N	1	1133-02-01
	1163-12-10	DG DBL 2-3/8 " GW W/ROD	1	1133-02-01

	CU-REF	CU-DESCRIPTION	QTY	MU-REF
4/0-4/0 TAN	1240-04-06	TIES PREFM SGL 4/0	3	1133-02-01
	1240-05-50	TIES PREFM SIDE 4/0 NEUTRAL	1	1133-02-01
	1119-10-02	GRD WOOD POLE W/BUTT COIL #6-4/0N	1	1133-02-01

1133-02	POLES, HARDWARE, AND FRAMING 3PH XARM FRAMING 10FT 3PH XARM TANGENT/ANGLE SINGLE 10 FT	 11/01
Sheet 3 of 3		
Rev 08/01/2020		

	CU-REF	CU-DESCRIPTION	QTY	MU-REF
4/0-4/0 ANG	1240-05-06	TIES PREFM SIDE SGL 4/0	3	1133-02-01
	1240-05-50	TIES PREFM SIDE 4/0 NEUTRAL	1	1133-02-01
	1119-10-02	GRD WOOD POLE W/BUTT COIL #6-4/0N	1	1133-02-01
	1163-12-20	DG DBL 1-7/16" W/ROD AND 1-3/8" GW	1	1133-02-01

	CU-REF	CU-DESCRIPTION	QTY	MU-REF
795-4/0 TAN	1240-04-10	TIES PREFM SGL 795	3	1133-02-01
	1240-05-50	TIES PREFM SIDE 4/0 NEUTRAL	1	1133-02-01
	1119-10-02	GRD WOOD POLE W/BUTT COIL #6-4/0N	1	1133-02-01

	CU-REF	CU-DESCRIPTION	QTY	MU-REF
795-4/0 ANG	1240-05-10	TIES PREFM SIDE SGL 795	3	1133-02-01
	1240-05-50	TIES PREFM SIDE 4/0 NEUTRAL	1	1133-02-01
	1119-10-02	GRD WOOD POLE W/BUTT COIL #6-4/0N	1	1133-02-01
	1163-12-20	DG DBL 1-7/16" W/ROD AND 1-3/8" GW	1	1133-02-01

1133-05
Sheet 1 of 3
Rev 08/01/2020

POLES, HARDWARE, AND FRAMING
3PH XARM FRAMING 10FT
3PH XARM TANGENT/ANGLE DBL 10 FT



11/01

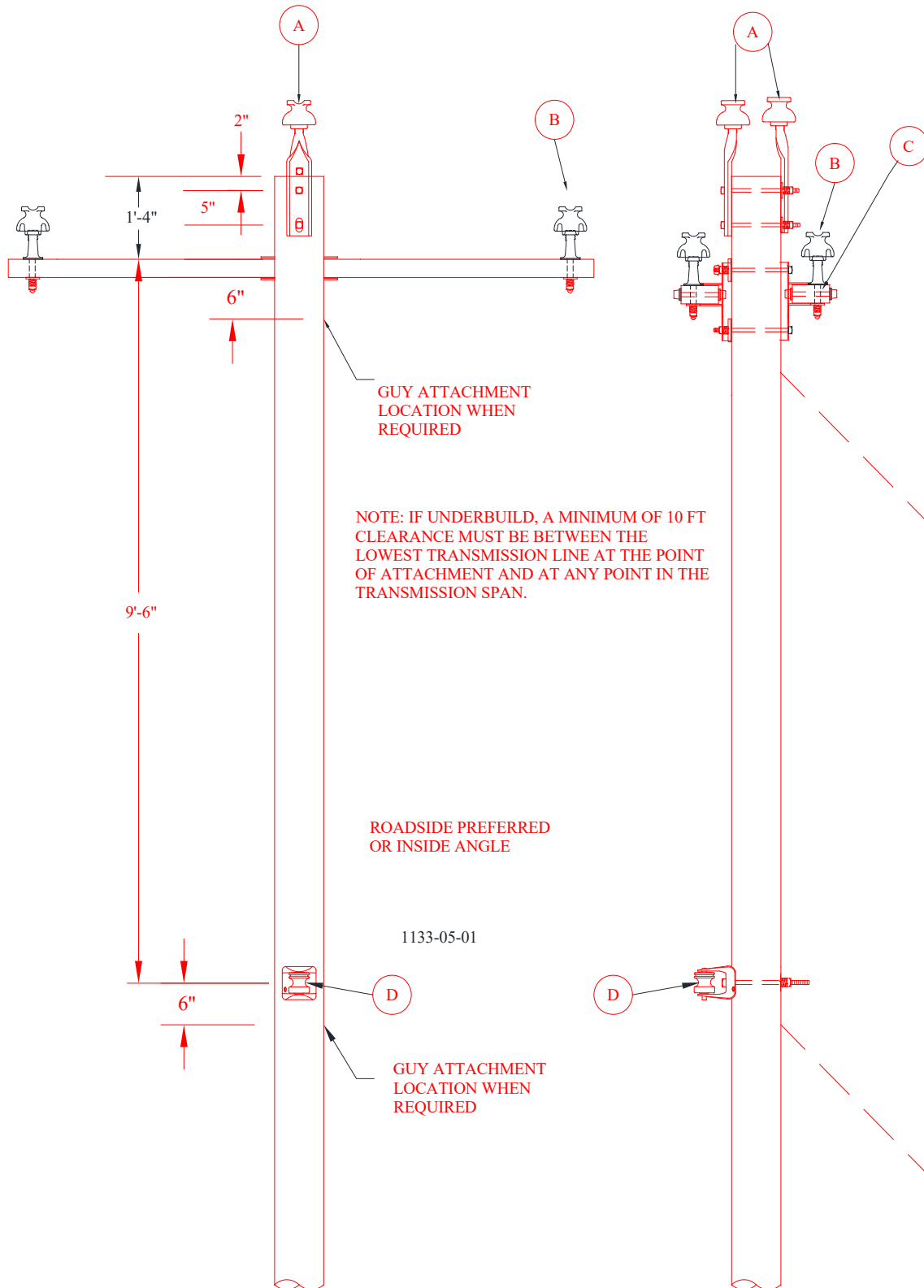

1133-05	POLES, HARDWARE, AND FRAMING 3PH XARM FRAMING 10FT 3PH XARM TANGENT/ANGLE DBL 10 FT	 11/01
Sheet 2 of 3		
Rev 08/01/2020		

MU

REFERENCE FOR SPAN LENGTH/ANGLE PARAMETERS

MU-REF	WIRE	PARAMETERS
1133-05-01	1/0	SPAN LENGTH > 300 FT
	4/0	SPAN LENGTH > 250 FT
	795	SPAN LENGTH > 250 FT
	1/0	ANGLE POLE < 30 DEGREES WITH SPAN LENGTH > 300 FT.
	4/0	ANGLE POLE > 09 AND < 18 DEGREES WITH SPAN LENGTH > 250 FT.
	795	ANGLE POLE > 09 AND < 18 DEGREES WITH SPAN LENGTH > 250 FT.

MU-ID

MU-REF

MU-DESCRIPTION

3PHXRTN/AGDBLPNSGLNU10FT 11330501 3PH XARM TAN/ANG DBL PIN SGL NU 10FT

ID	CU-REF	CU-DESC	QTY	MU-REF
B	11200802	INSULATOR W/LONG SHANK PIN	4	11330501
C	11201508	ARM FIBERGLASS LD SGL 10 FT	1	11330501
D	11201003	BRKT RACK 1 POINT 14 IN-SGL	1	11330501
A	11200702	INSULATOR W/FIBERGLASS POLE TOP PIN-DBL	1	11330501

NOTE ADD MODULE 11201003 WHEN SECOND BRACKET IS REQUIRED FOR SECONDARY SERVICE

ASSOCIATED MODULES

	CU-REF	CU-DESCRIPTION	QTY	MU-REF
1/0-1/0 TAN	1240-04-23	TIES PREFM DBL 1/0	3	1133-05-01
	1240-05-40	TIES PREFM SIDE 1/0 NEUTRAL	1	1133-05-01
	1119-10-01	GRD WOOD POLE W/BUTT COIL #6 TO 1/0N	1	1133-05-01

	CU-REF	CU-DESCRIPTION	QTY	MU-REF
1/0-1/0 ANG	1240-05-23	TIES PREFM SIDE DBL 1/0	3	1133-05-01
	1240-05-40	TIES PREFM SIDE 1/0 NEUTRAL	1	1133-05-01
	1119-10-01	GRD WOOD POLE W/BUTT COIL #6 TO 1/0N	1	1133-05-01
	1163-12-10	DG DBL 2-3/8 " GW W/ROD	1	1133-05-01

	CU-REF	CU-DESCRIPTION	QTY	MU-REF
4/0-4/0 TAN	1240-04-26	TIES PREFM DBL 4/0	3	1133-05-01
	1240-05-50	TIES PREFM SIDE 4/0 NEUTRAL	1	1133-05-01
	1119-10-02	GRD WOOD POLE W/BUTT COIL #6 TO 4/0N	1	1133-05-01

1133-05	POLES, HARDWARE, AND FRAMING 3PH XARM FRAMING 10FT 3PH XARM TANGENT/ANGLE DBL 10 FT	 11/01
Sheet 3 of 3		
Rev 08/01/2020		

	CU-REF	CU-DESCRIPTION	QTY	MU-REF
4/0-4/0 ANG	1240-05-26	TIES PREFM SIDE DBL 4/0	3	1133-05-01
	1240-05-50	TIES PREFM SIDE 4/0 NEUTRAL	1	1133-05-01
	1119-10-02	GRD WOOD POLE W/BUTT COIL #6 TO 4/0N	1	1133-05-01
	1163-12-20	DG DBL 1-7/16" W/ROD AND 1-3/8" GW	1	1133-05-01

	CU-REF	CU-DESCRIPTION	QTY	MU-REF
795-4/0 TAN	1240-04-30	TIES PREFM DBL 795	3	1133-05-01
	1240-05-50	TIES PREFM SIDE 4/0 NEUTRAL	1	1133-05-01
	1119-10-02	GRD WOOD POLE W/BUTT COIL #6 TO 4/0N	1	1133-05-01

	CU-REF	CU-DESCRIPTION	QTY	MU-REF
795-4/0 ANG	1240-05-30	TIES PREFM SIDE DBL 795	3	1133-05-01
	1240-05-50	TIES PREFM SIDE 4/0 NEUTRAL	1	1133-05-01
	1119-10-02	GRD WOOD POLE W/BUTT COIL #6 TO 4/0N	1	1133-05-01
	1163-12-20	DG DBL 1-7/16" W/ROD AND 1-3/8" GW	1	1133-05-01

1133-22
Sheet 1 of 2
Rev 08/01/2020

POLES, HARDWARE, AND FRAMING
3PH XARM FRAMING 10FT
3PH XARM SINGLE DEAD END HD 10 FT



11/01

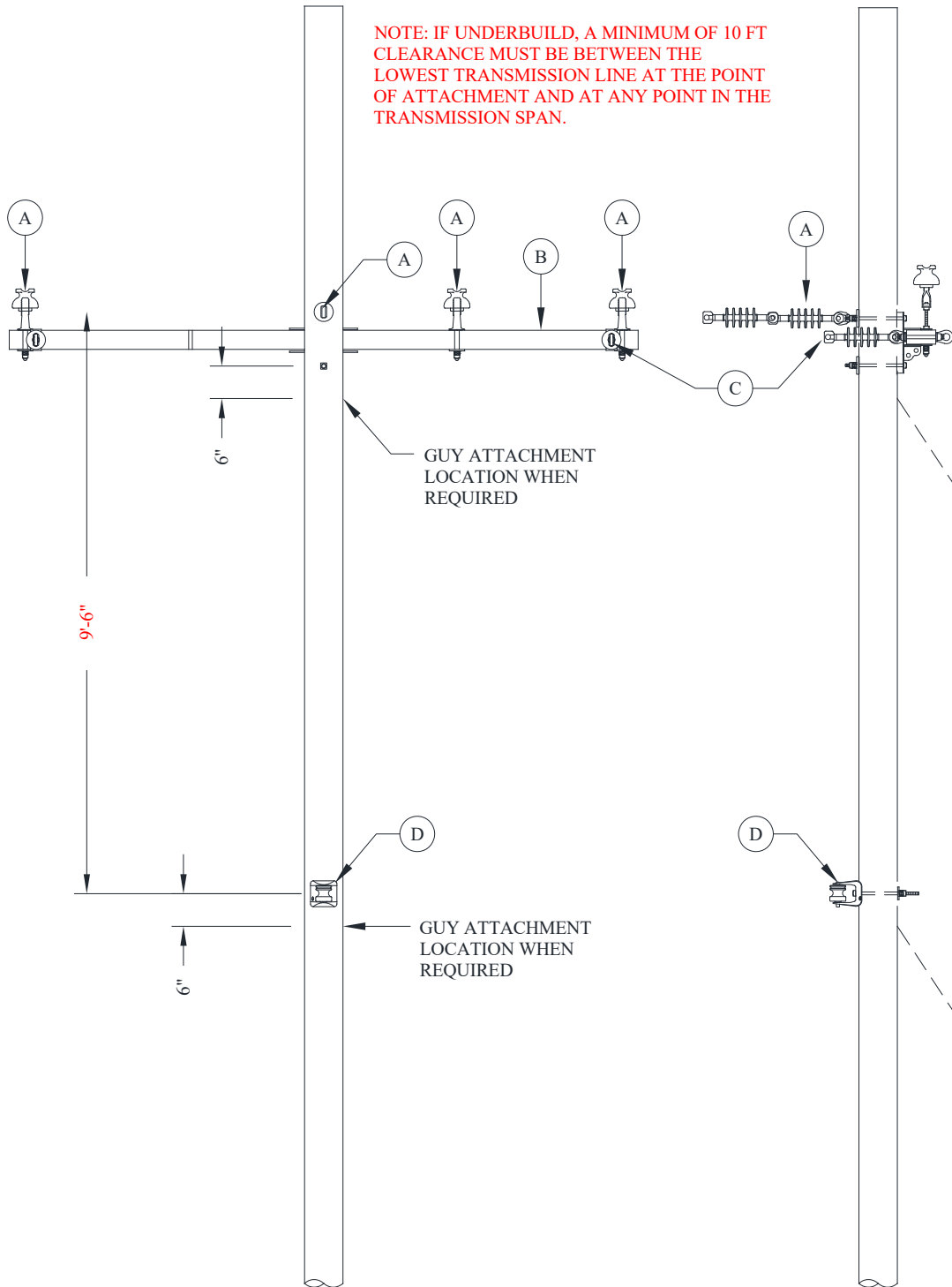

1133-22	POLES, HARDWARE, AND FRAMING 3PH XARM FRAMING 10FT 3PH XARM SINGLE DEAD END HD 10 FT	 11/01
Sheet 2 of 2		
Rev 08/01/2020		

MU

MU-ID	MU-REF	MU-DESCRIPTION
3PHXRSDEHD10FT	11332201	3PH XARM SGL DE HD 10FT

ID	CU-REF	CU-DESC	QTY	MU-REF
A	11201704	INSULATOR DE SGL W/3/4" EYENUT	1	11332201
B	11201612	ARM FIBERGLASS DE HD 10 FT	1	11332201
C	11201701	INSULATOR DE SGL	2	11332201
D	11201003	BRKT RACK 1 POINT 14 IN-SGL	1	11332201

NOTE ADD MODULE 11201003 WHEN SECOND BRACKET IS REQUIRED FOR SECONDARY SERVICE

ASSOCIATED MODULES

	CU-REF	CU-DESCRIPTION	QTY	MU-REF
1/0-1/0	1240-01-01	DEAD END CLAMP 1/0-4/0	3	1133-22-01
	1240-03-11	DEAD END PREFM 1/0 ACSR	1	1133-22-01
	1119-10-01	GRD WOOD POLE W/BUTT COIL #6 TO 1/0N	1	1133-22-01
	1163-12-10	DG DBL 2-3/8" GW W/ROD	1	1133-22-01

	CU-REF	CU-DESCRIPTION	QTY	MU-REF
4/0-1/0	1240-01-01	DEAD END CLAMP 1/0-4/0	3	1133-22-01
	1240-03-40	DEAD END PREFM 4/0 AAC/ACSR	1	1133-22-01
	1119-10-02	GRD WOOD POLE W/BUTT COIL #6 TO 4/0N	1	1133-22-01
	1163-12-20	DG DBL 1-7/16" W/ROD AND 1-3/8" GW	1	1133-22-01

	CU-REF	CU-DESCRIPTION	QTY	MU-REF
795-4/0	1240-01-07	DEAD-END CLAMP 795	3	1133-22-01
	1240-03-40	DEAD END PREFM 4/0 AAC/ACSR	1	1133-22-01
	1119-10-02	GRD WOOD POLE W/BUTT COIL #6 TO 4/0N	1	1133-22-01
	1163-14-20	DG TPL 2-7/16" W/ROD AND 1-3/8" GW	1	1133-22-01

1133-42
Sheet 1 of 3
Rev 08/01/2020

POLES, HARDWARE, AND FRAMING
3PH XARM FRAMING 10FT
3PH XARM SGL DE CORNER POLE 10 FT



11/01

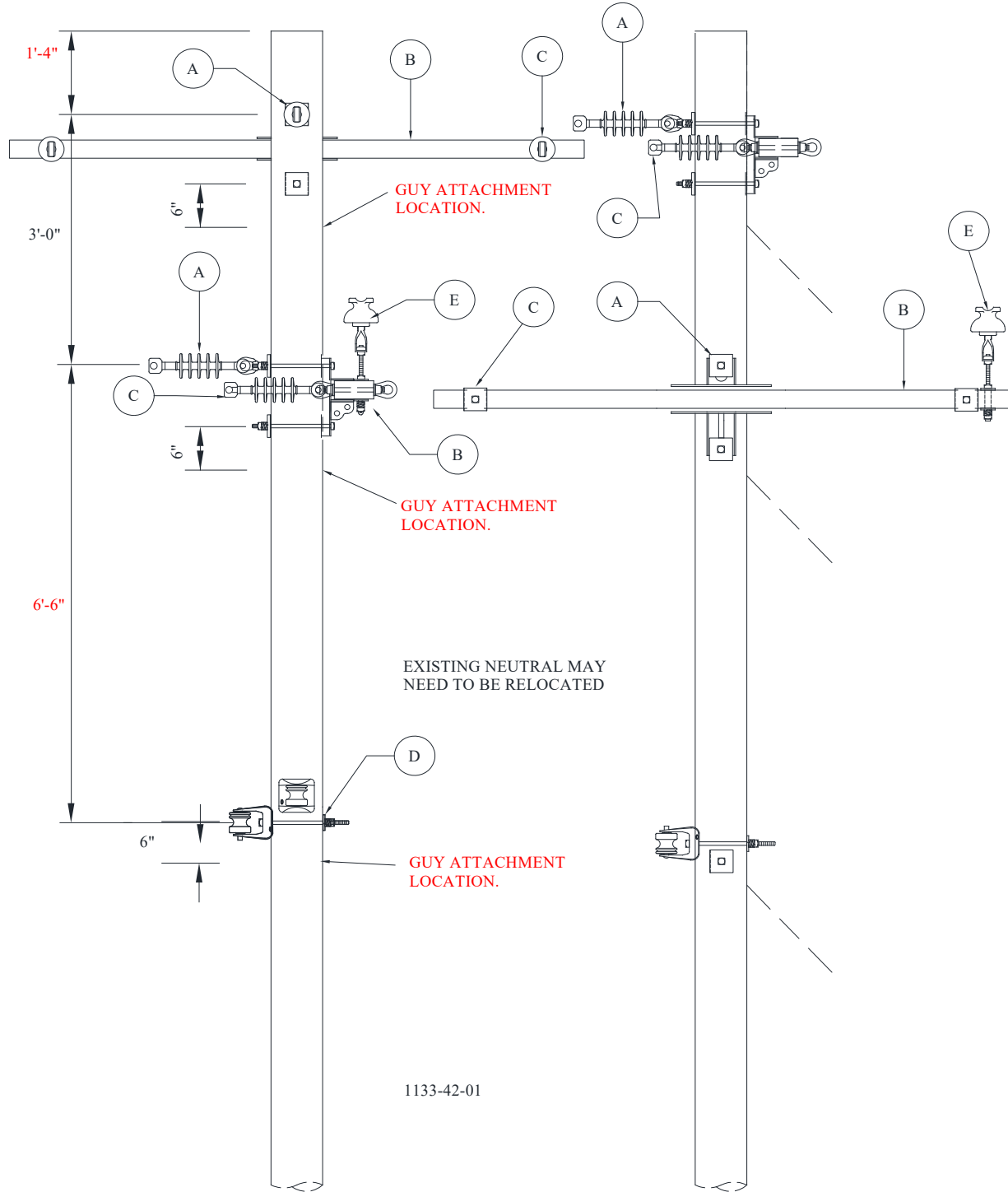

1133-42	POLES, HARDWARE, AND FRAMING 3PH XARM FRAMING 10FT 3PH XARM SGL DE CORNER POLE 10 FT	 11/01
Sheet 2 of 3		
Rev 08/01/2020		

MU

MU-ID	MU-REF	MU-DESCRIPTION
3PHXRSDECNHD10FT	11334201	3PH XARM SGL DE CORNER 10FT

ID	CU-REF	CU-DESC	QTY	MU-REF
A	11201704	INSULATOR DE SGL W/3/4" EYENUT	2	11334201
B	11201612	ARM FIBERGLASS DE HD 10 FT	2	11334201
C	11201701	INSULATOR DE SGL	4	11334201
D	11201003	BRKT RACK 1 POINT 14 IN-SGL	2	11334201
E	11200901	INSULATOR W/ADAPTOR PIN	1	11334201

NOTE ADD MODULE 11201003 WHEN SECOND BRACKET IS REQUIRED FOR SECONDARY SERVICE

ASSOCIATED MODULES-FULL TENSION

	CU-REF	CU-DESCRIPTION	QTY	MU-REF
1/0-1/0	1240-01-01	DEAD-END CLAMP 1/0-4/0	6	1133-42-01
	1119-10-01	GRD WOOD POLE W/BUTT COIL #6-1/0N	1	1133-42-01
	1163-12-10	DG DBL 2-3/8" GW W/ROD	2	1133-42-01
	1240-03-11	DEAD END PREFM 1/0 ACSR	2	1133-42-01
	1240-04-03	TIES PREFM SGL 1/0	1	1133-42-01
	1245-02-04	H-TAP CU/AL 1/0-1/0	7	1133-42-01

	CU-REF	CU-DESCRIPTION	QTY	MU-REF
4/0 -4/0	1240-01-01	DEAD-END CLAMP 1/0-4/0	6	1133-42-01
	1119-10-02	GRD WOOD POLE W/BUTT COIL #6-4/0N	1	1133-42-01
	1163-12-20	DG DBL 1-7/16" W/ROD AND 1-3/8" GW	2	1133-42-01
	1240-03-40	DEAD END PREFM 4/0 AAC/ACSR	2	1133-42-01
	1240-04-06	TIES PREFM SGL 4/0	1	1133-42-01
	1245-02-07	H-TAP CU/AL 4/0-4/0	7	1133-42-01

	CU-REF	CU-DESCRIPTION	QTY	MU-REF
795-4/0	1240-01-07	DEAD-END CLAMP 795	6	1133-42-01
	1119-10-02	GRD WOOD POLE W/BUTT COIL #6-4/0N	1	1133-42-01
	1163-14-20	DG TPL 2-7/16" W/ROD AND 1-3/8" GW	2	1133-42-01
	1240-03-40	DEAD END PREFM 4/0 AAC/ACSR	2	1133-42-01
	1245-07-77	CLAMP 2-BOLT 795-795	6	1133-42-01
	1240-04-10	TIES PREFM SGL 795	1	1133-42-01
	1245-02-07	H-TAP CU/AL 4/0-4/0	1	1133-42-01

1133-42	POLES, HARDWARE, AND FRAMING	 11/01
Sheet 3 of 3	3PH XARM FRAMING 10FT	
Rev 08/01/2020	3PH XARM SGL DE CORNER POLE 10 FT	

ASSOCIATED MODULES-REDUCED TENSION

	CU-REF	CU-DESCRIPTION	QTY	MU-REF
1/0-1/0	1240-01-01	DEAD-END CLAMP 1/0-4/0	6	1133-42-01
	1119-10-01	GRD WOOD POLE W/BUTT COIL #6-1/0N	1	1133-42-01
	1240-03-11	DEAD END PREFM 1/0 ACSR	2	1133-42-01
	1240-04-03	TIES PREFM SGL 1/0	1	1133-42-01
	1245-02-04	H-TAP CU/AL 1/0-1/0	7	1133-42-01

	CU-REF	CU-DESCRIPTION	QTY	MU-REF
4/0 -4/0	1240-01-01	DEAD-END CLAMP 1/0-4/0	6	1133-42-01
	1119-10-02	GRD WOOD POLE W/BUTT COIL #6-4/0N	1	1133-42-01
	1240-03-40	DEAD END PREFM 4/0 AAC/ACSR	2	1133-42-01
	1240-04-06	TIES PREFM SGL 4/0	1	1133-42-01
	1245-02-07	H-TAP CU/AL 4/0-4/0	7	1133-42-01

	CU-REF	CU-DESCRIPTION	QTY	MU-REF
795-4/0	1240-01-07	DEAD-END CLAMP 795	6	1133-42-01
	1119-10-02	GRD WOOD POLE W/BUTT COIL #6-4/0N	1	1133-42-01
	1240-03-40	DEAD END PREFM 4/0 AAC/ACSR	2	1133-42-01
	1240-04-10	TIES PREFM SGL 795	1	1133-42-01
	1245-07-77	CLAMP 2-BOLT 795-795	6	1133-42-01
	1245-02-07	H-TAP CU/AL 4/0-4/0	1	1133-42-01

1133-52
Sheet 1 of 4
Rev 08/01/2020

POLES, HARDWARE, AND FRAMING

**3PH XARM FRAMING 10FT
3PH XARM DBL DEAD END 10 FT**



11/01

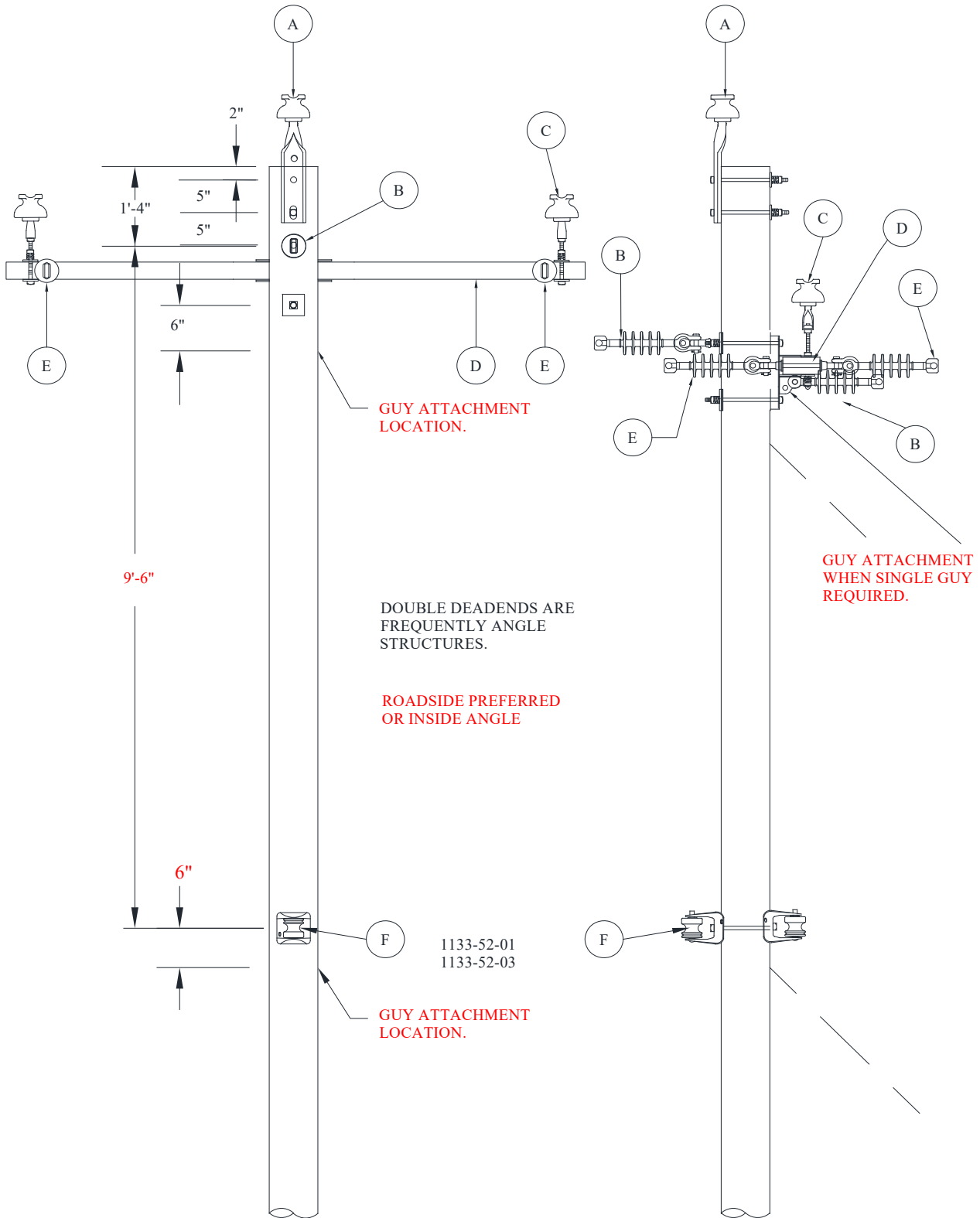

1133-52	POLES, HARDWARE, AND FRAMING 3PH XARM FRAMING 10FT 3PH XARM DBL DEAD END 10 FT	 11/01
Sheet 2 of 4		
Rev 08/01/2020		

MU

REFERENCE FOR SPAN LENGTH/ANGLE PARAMETERS

MU-REF	WIRE	PARAMETERS
1133-52-01	1/0	ANGLE POLE > 30 DEGREES AND < 60 DEGREES
	4/0	ANGLE POLE > 18 DEGREES AND < 30 DEGREES
	795	ANGLE POLE > 18 DEGREES AND < 30 DEGREES
1133-52-03	1/0	FULL TENSION DEADEND W/REDUCED TENSION SPAN
	4/0	FULL TENSION DEADEND W/REDUCED TENSION SPAN
	795	FULL TENSION DEADEND W/REDUCED TENSION SPAN

MU-ID

MU-REF

MU-DESCRIPTION

3PHXRDDDEHD10FT

11335201

3PH XARM DBL DE ANGLE HD 10FT

ID	CU-REF	CU-DESC	QTY	MU-REF
A	11201713	INSULATOR DE SGL W/3/4" EYENUT/SHACKLE	1	11335201
B	11200901	INSULATOR W/ADAPTOR PIN	3	11335201
C	11201612	ARM FIBERGLASS DE HD 10 FT	1	11335201
D	11201710	INSULATOR DE SGL W/SHACKLE	4	11335201
E	11201009	BRKT RACK 1 POINT 14 IN-DBL	1	11335201
F	11201714	INSULATOR DE SGL W/3/4" EYEBOLT/SHACKLE	1	11335201

3PHXRDDERTNHD10FT

11335203

3PH XARM DBL DE REDUCED TEN HD 10FT

ID	CU-REF	CU-DESC	QTY	MU-REF
A	11201704	INSULATOR DE SGL W/3/4" EYENUT	1	11335203
B	11200901	INSULATOR W/ADAPTOR PIN	3	11335203
C	11201612	ARM FIBERGLASS DE HD 10 FT	1	11335203
D	11201710	INSULATOR DE SGL W/SHACKLE	4	11335203
E	11201003	BRKT RACK 1 POINT 14 IN-SGL	2	11335203
F	11201714	INSULATOR DE SGL W/3/4" EYEBOLT/SHACKLE	1	11335203

ASSOCIATED MODULES-

	CU-REF	CU-DESCRIPTION	QTY	MU-REF
1/0-1/0	1240-01-01	DEAD END CLAMP 1/0-4/0	6	ALL GROUPS
	1240-04-03	TIES PREFM SGL 1/0	3	ALL GROUPS
	1240-03-11	DEAD END PREFM 1/0 ACSR	2	ALL GROUPS
	1119-10-01	GRD WOOD POLE W/BUTT COIL #6-1/0N	1	ALL GROUPS
	1163-12-10	DG DBL 2-3/8" GW W/ROD	1	ALL GROUPS
	1245-02-04	H-TAP CU/AL 1/0-1/0	8	ALL GROUPS

1133-52
Sheet 3 of 4
Rev 08/01/2020

POLES, HARDWARE, AND FRAMING
3PH XARM FRAMING 10FT
3PH XARM DBL DEAD END 10 FT



11/01

	CU-REF	CU-DESCRIPTION	QTY	MU-REF
4/0-4/0	1240-01-01	DEAD END CLAMP 1/0-4/0	6	ALL GROUPS
	1240-04-06	TIES PREFM SGL 4/0	3	ALL GROUPS
	1240-03-40	DEAD END PREFM 4/0 AAC/ACSR	2	ALL GROUPS
	1119-10-02	GRD WOOD POLE W/BUTT COIL #6-4/0N	1	ALL GROUPS
	1163-12-20	DG DBL 1-7/16" W/ROD AND 1-3/8" GW	1	ALL GROUPS
	1245-02-07	H-TAP CU/AL 4/0-4/0	8	ALL GROUPS

	CU-REF	CU-DESCRIPTION	QTY	MU-REF
795-4/0	1240-01-07	DEAD END CLAMP 795	6	ALL GROUPS
	1240-04-10	TIES PREFM SGL 795	3	ALL GROUPS
	1240-03-40	DEAD END PREFM 4/0 AAC/ACSR	2	ALL GROUPS
	1119-10-02	GRD WOOD POLE W/BUTT COIL #6-4/0N	1	ALL GROUPS
	1163-14-20	DG TPL 2-7/16" W/ROD AND 1-3/8" GW	1	ALL GROUPS
	1245-07-77	CLAMP 2-BOLT 795-795	6	ALL GROUPS
	1245-02-07	H-TAP CU/AL 4/0-4/0	2	ALL GROUPS

1133-55
Sheet 1 of 3
Rev 08/01/2020

POLES, HARDWARE, AND FRAMING

3PH XARM FRAMING 10FT

3PH XARM JUNCTION 10 FT



11/01

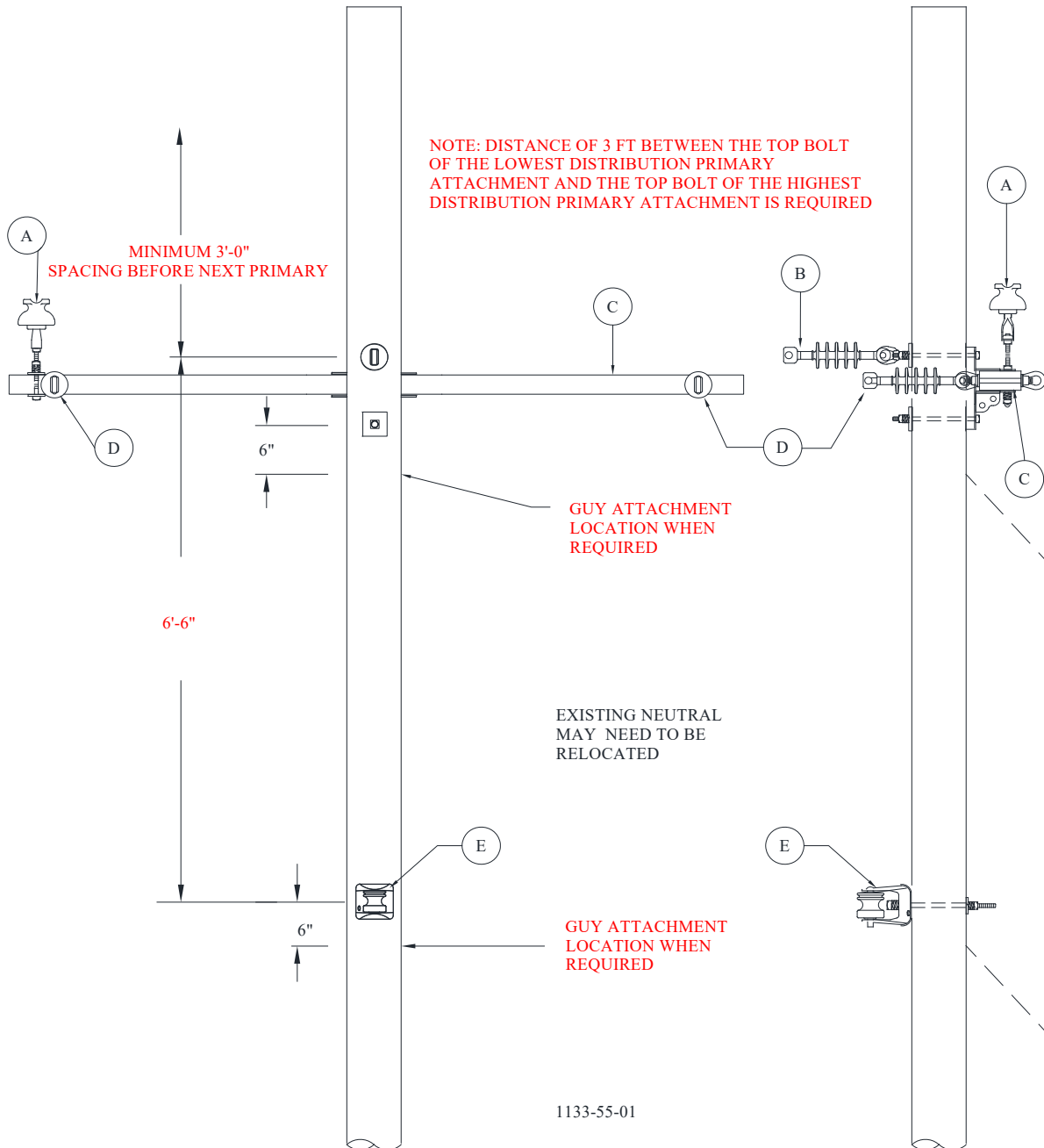

1133-55	POLES, HARDWARE, AND FRAMING 3PH XARM FRAMING 10FT 3PH XARM JUNCTION 10 FT	 11/01
Sheet 2 of 3		
Rev 08/01/2020		

MU

MU-ID	MU-REF	MU-DESCRIPTION
3PHXRSDEJNHD10FT	11335501	3PH XARM SGL DE JUNCTION HD 10FT

ID	CU-REF	CU-DESC	QTY	MU-REF
A	11201704	INSULATOR DE SGL W/3/4" EYENUT	1	11335501
B	11200901	INSULATOR W/ADAPTOR PIN	1	11335501
C	11201612	ARM FIBERGLASS DE HD 10 FT	1	11335501
D	11201710	INSULATOR DE SGL W/SHACKLE	2	11335501
E	11201010	BRKT RACK 1 POINT DBL	1	11335501

ASSOCIATED MODULES-FULL TENSION

	CU-REF	CU-DESCRIPTION	QTY	MU-REF
1/0-1/0	1240-01-01	DEAD-END CLAMP 1/0-4/0	3	1133-55-01
	1240-03-11	DEAD END PREFM 1/0 ACSR	1	1133-55-01
	1163-12-10	DOWN GUY DBL 3/8" GUY W 8' STRAIN ROD	1	1133-55-01

	CU-REF	CU-DESCRIPTION	QTY	MU-REF
4/0-4/0	1240-01-01	DEAD-END CLAMP 1/0-4/0	3	1133-55-01
	1240-03-40	DEAD END PREFM 4/0 AAC/ACSR	1	1133-55-01
	1163-12-20	DG DBL 1-7/16" W/ROD AND 1-3/8" GW	1	1133-55-01

	CU-REF	CU-DESCRIPTION	QTY	MU-REF
795-4/0	1240-01-07	DEAD-END CLAMP 795	3	1133-55-01
	1240-03-40	DEAD END PREFM 4/0 AAC/ACSR	1	1133-55-01
	1163-14-20	DG TPL 2-7/16" W/ROD AND 1-3/8" GW	1	1133-55-01

ASSOCIATED MODULES-SLACK TENSION

	CU-REF	CU-DESCRIPTION	QTY	MU-REF
1/0-1/0	1240-01-01	DEAD-END CLAMP 1/0-4/0	3	1133-55-01
	1240-03-11	DEAD END PREFM 1/0 ACSR	1	1133-55-01

	CU-REF	CU-DESCRIPTION	QTY	MU-REF
4/0-4/0	1240-01-01	DEAD-END CLAMP 1/0-4/0	3	1133-55-01
	1240-03-40	DEAD END PREFM 4/0 AAC/ACSR	1	1133-55-01

1133-55	POLES, HARDWARE, AND FRAMING 3PH XARM FRAMING 10FT 3PH XARM JUNCTION 10 FT	 11/01
Sheet 2 of 3		
Rev 08/01/2020		

	CU-REF	CU-DESCRIPTION	QTY	MU-REF
795-4/0	1240-01-07	DEAD-END CLAMP 795	3	1133-55-01
	1240-03-40	DEAD END PREFM 4/0 AAC/ACSR	1	1133-55-01

ASSOCIATED MODULES- JUMPERS

	CU-REF	CU-DESCRIPTION	QTY	MU-REF
1/0-1/0	1245-02-04	H-TAP CU/AL 1/0-1/0	7	1133-55-01
	1240-04-03	TIES PREFM SGL 1/0	2	1133-55-01

	CU-REF	CU-DESCRIPTION	QTY	MU-REF
4/0-4/0	1245-02-07	H-TAP CU/AL 4/0-4/0	7	1133-55-01
	1240-04-06	TIES PREFM SGL 4/0	2	1133-55-01

	CU-REF	CU-DESCRIPTION	QTY	MU-REF
4/0-795	1245-07-85	CLAMP 1-BOLT CU/AL 795-336	6	1133-55-01
	1240-04-06	TIES PREFM SGL 4/0	2	1133-55-01
	1245-02-07	H-TAP CU/AL 4/0-4/0	1	1133-55-01

	CU-REF	CU-DESCRIPTION	QTY	MU-REF
795-795	1245-07-77	CLAMP 2-BOLT 795-795	6	1133-55-01
	1245-02-07	H-TAP CU/AL 4/0-4/0	1	1133-55-01
	1240-04-10	TIES PREFM SGL 795	2	1133-55-01

ASSOCIATED MODULES-FUSED

	CU-REF	CU-DESCRIPTION	QTY	MU-REF
1/0-1/0	1245-02-04	H-TAP CU/AL 1/0-1/0	1	1133-55-01
	1368-12-20	LINE FUSE ASSY 8/10' DE ARM 1/0 PRI	3	1133-55-01

	CU-REF	CU-DESCRIPTION	QTY	MU-REF
4/0-1/0	1245-02-06	H-TAP CU/AL 4/0-1/0	1	1133-55-01
	1368-12-21	LINE FUSE ASSY 8/10' DE ARM 4/0 PRI	3	1133-55-01

	CU-REF	CU-DESCRIPTION	QTY	MU-REF
795-1/0	1245-02-06	H-TAP CU/AL 4/0-1/0	1	1133-55-01
	1368-12-24	LINE FUSE ASSY 8/10' DE ARM 795 PRI	3	1133-55-01

ASSOCIATED MODULES-HOT TAP JUMPERS

1133-55	POLES, HARDWARE, AND FRAMING 3PH XARM FRAMING 10FT 3PH XARM JUNCTION 10 FT	 11/01
Sheet 2 of 3		
Rev 08/01/2020		

	CU-REF	CU-DESCRIPTION	QTY	MU-REF
1/0-1/0	1245-02-04	H-TAP CU/AL 1/0-1/0	1	1133-55-01
	1368-05-40	JUMPER ASSY - HOT TAP 1/0 AL PRI	3	1133-55-01

1133-60
Sheet 1 of 3
Rev 08/01/2020

POLES, HARDWARE, AND FRAMING
3PH XARM FRAMING 10FT
3PH SGL ALLEY ARM 10 FT



NOTE: IF UNDERBUILD, A MINIMUM OF 10 FT
CLEANANCE MUST BE BETWEEN THE LOWEST
TRANSMISSION LINE AND THE HIGHEST
DISTRIBUTION LINE AT THE POINT OF ATTACHMENT
AND AT ANY POINT IN THE TRANSMISSION SPAN.

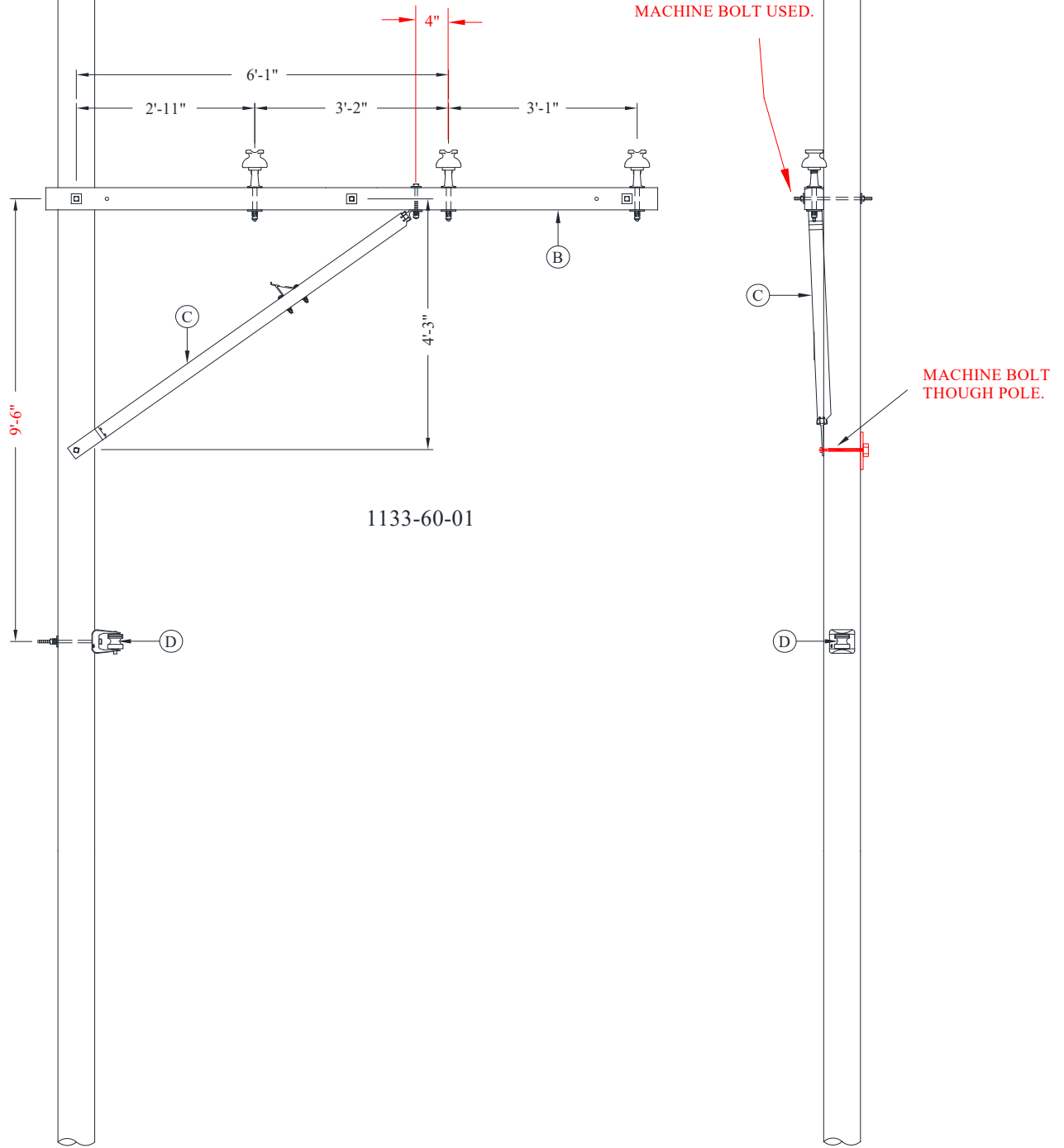

1133-60	POLES, HARDWARE, AND FRAMING	 AUSTIN ENERGY
Sheet 2 of 3	3PH XARM FRAMING 10FT	
Rev 08/01/2020	3PH SGL ALLEY ARM 10 FT	

11/01

MU**REFERENCE FOR SPAN LENGTH/ANGLE PARAMETERS**

MU-REF	WIRE	PARAMETERS
1133-60-01	1/0	SPAN LENGTH < 300 FT
	4/0	SPAN LENGTH < 250 FT
	795	SPAN LENGTH < 250 FT
	1/0	ANGLE POLE < 30 DEGREES WITH SPAN LENGTH < 300 FT.
	4/0	ANGLE POLE < 09 DEGREES WITH SPAN LENGTH < 250 FT.
	795	ANGLE POLE < 09 DEGREES WITH SPAN LENGTH < 250 FT.

MU-ID**MU-REF****MU-DESCRIPTION**

3PHAATN/AGSGLPNSGLNU10FT 11336001 3PH ALLEY ARM TAN/ANG SGL PIN SGL NU 10'

ID	CU-REF	CU-DESC	QTY	MU-REF
A	11200802	INSULATOR W/LONG SHANK PIN	3	11336001
B	11201503	ARM WOOD SGL LD 10 FT	1	11336001
C	11201406	WOOD BRACE 7 FT FOR SGL 10 FT ALLEY ARM	1	11336001
D	11201003	BRKT RACK 1 POINT 14 IN-SGL	1	11336001

NOTE ADD MODULE 11201003 WHEN SECOND BRACKET IS REQUIRED FOR SECONDARY SERVICE**ASSOCIATED MODULES**

	CU-REF	CU-DESCRIPTION	QTY	MU-REF
1/0-1/0 TAN	1240-04-03	TIES PREFM SGL 1/0	3	1133-60-01
	1240-05-40	TIES PREFM SIDE 1/0 NEUTRAL	1	1133-60-01
	1119-10-01	GRD WOOD POLE W/BUTT COIL #6 TO 1/0N	1	1133-60-01

	CU-REF	CU-DESCRIPTION	QTY	MU-REF
1/0-1/0 ANG	1240-05-03	TIES PREFM SIDE SGL 1/0	3	1133-60-01
	1240-05-40	TIES PREFM SIDE 1/0 NEUTRAL	1	1133-60-01
	1119-10-01	GRD WOOD POLE W/BUTT COIL #6 TO 1/0N	1	1133-60-01
	1163-12-10	DG DBL 2-3/8 " GW W/ROD	1	1133-60-01

	CU-REF	CU-DESCRIPTION	QTY	MU-REF
4/0-4/0 TAN	1240-04-06	TIES PREFM SGL 4/0	3	1133-60-01
	1240-05-50	TIES PREFM SIDE 4/0 NEUTRAL	1	1133-60-01
	1119-10-02	GRD WOOD POLE W/BUTT COIL #6 TO 4/0N	1	1133-60-01

1133-60	POLES, HARDWARE, AND FRAMING	 11/01
Sheet 3 of 3	3PH XARM FRAMING 10FT	
Rev 08/01/2020	3PH SGL ALLEY ARM 10 FT	

	CU-REF	CU-DESCRIPTION	QTY	MU-REF
4/0-4/0 ANG	1240-05-06	TIES PREFM SIDE SGL 4/0	3	1133-60-01
	1240-05-50	TIES PREFM SIDE 4/0 NEUTRAL	1	1133-60-01
	1119-10-02	GRD WOOD POLE W/BUTT COIL #6 TO 4/0N	1	1133-60-01
	1163-12-20	DG DBL 1-7/16" W/ROD AND 1-3/8" GW	1	1133-60-01

	CU-REF	CU-DESCRIPTION	QTY	MU-REF
795-4/0 TAN	1240-04-10	TIES PREFM SGL 795	3	1133-60-01
	1240-05-50	TIES PREFM SIDE 4/0 NEUTRAL	1	1133-60-01
	1119-10-02	GRD WOOD POLE W/BUTT COIL #6 TO 4/0N	1	1133-60-01

	CU-REF	CU-DESCRIPTION	QTY	MU-REF
795-4/0 ANG	1240-05-10	TIES PREFM SIDE SGL 795	3	1133-60-01
	1240-05-50	TIES PREFM SIDE 4/0 NEUTRAL	1	1133-60-01
	1119-10-02	GRD WOOD POLE W/BUTT COIL #6 TO 4/0N	1	1133-60-01
	1163-12-20	DG DBL 1-7/16" W/ROD AND 1-3/8" GW	1	1133-60-01

1133-61
Sheet 1 of 3
Rev 08/01/2020

POLES, HARDWARE, AND FRAMING
3PH XARM FRAMING 10FT
3PH DBL ALLEY ARM 10 FT



NOTE: IF UNDERBUILD, A MINIMUM OF 10 FT
CLEANANCE MUST BE BETWEEN THE LOWEST
TRANSMISSION LINE AND THE HIGHEST
DISTRIBUTION LINE AT THE POINT OF ATTACHMENT
AND AT ANY POINT IN THE TRANSMISSION SPAN.

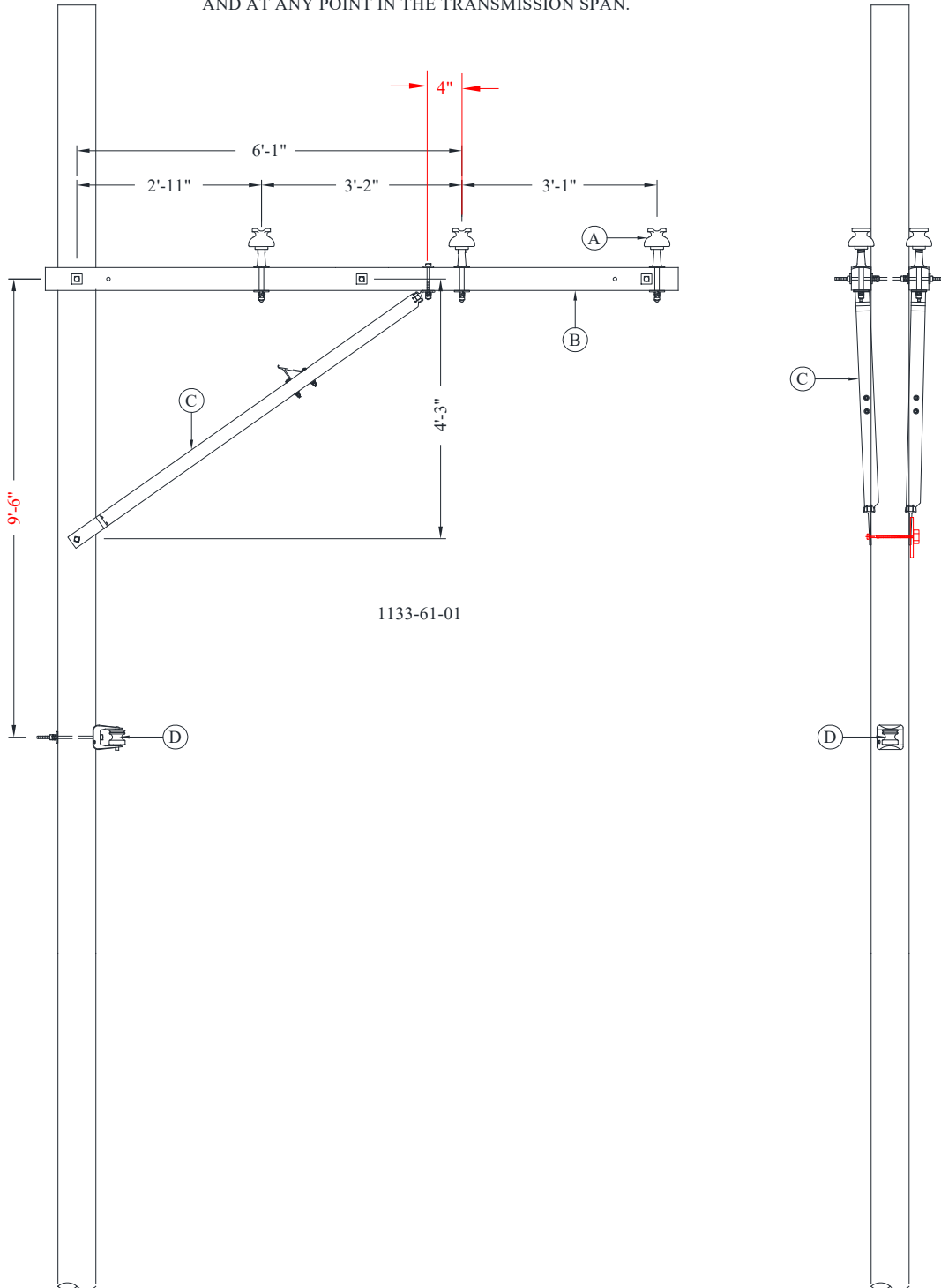

1133-61	POLES, HARDWARE, AND FRAMING	 11/01
Sheet 2 of 3	3PH XARM FRAMING 10FT	
Rev 08/01/2020	3PH DBL ALLEY ARM 10 FT	

MU

REFERENCE FOR SPAN LENGTH/ANGLE PARAMETERS

MU-REF	WIRE	PARAMETERS
1133-61-01	1/0	SPAN LENGTH > 300 FT
	4/0	SPAN LENGTH > 250 FT
	795	SPAN LENGTH > 250 FT
	1/0	ANGLE POLE < 30 DEGREES WITH SPAN LENGTH > 300 FT.
	4/0	ANGLE POLE > 09 AND < 18 DEGREES WITH SPAN LENGTH > 250 FT.
	795	ANGLE POLE > 09 AND < 18 DEGREES WITH SPAN LENGTH > 250 FT.

MU-ID

MU-REF

MU-DESCRIPTION

3PHAATN/ANDBLPNSGLNU10FT 11336101 3PH ALLEY ARM TAN/ANG DBL PIN SGL NU 10'

ID	CU-REF	CU-DESC	QTY	MU-REF
A	11200802	INSULATOR W/LONG SHANK PIN	6	11336101
B	11201504	ARM WOOD DBL LD 10 FT	1	11336101
C	11201407	WOOD BRACE 7 FT FOR DBL 10 FT ALLEY ARM	1	11336101
D	11201003	BRKT RACK 1 POINT 14 IN-SGL	1	11336101

NOTE ADD MODULE 11201003 WHEN SECOND BRACKET IS REQUIRED FOR SECONDARY SERVICE

ASSOCIATED MODULES

	CU-REF	CU-DESCRIPTION	QTY	MU-REF
1/0-1/0 TAN	1240-04-23	TIES PREFM DBL 1/0	3	1133-61-01
	1240-05-40	TIES PREFM SIDE 1/0 NEUTRAL	1	1133-61-01
	1119-10-01	GRD WOOD POLE W/BUTT COIL #6 TO 1/0N	1	1133-61-01

	CU-REF	CU-DESCRIPTION	QTY	MU-REF
1/0-1/0 ANG	1240-05-23	TIES PREFM SIDE DBL 1/0	3	1133-61-01
	1240-05-40	TIES PREFM SIDE 1/0 NEUTRAL	1	1133-61-01
	1119-10-01	GRD WOOD POLE W/BUTT COIL #6 TO 1/0N	1	1133-61-01
	1163-12-10	DG DBL 2-3/8 " GW W/ROD	1	1133-61-01

	CU-REF	CU-DESCRIPTION	QTY	MU-REF
4/0-4/0 TAN	1240-04-26	TIES PREFM DBL 4/0	3	1133-61-01
	1240-05-50	TIES PREFM SIDE 4/0 NEUTRAL	1	1133-61-01
	1119-10-02	GRD WOOD POLE W/BUTT COIL #6 TO 4/0N	1	1133-61-01

1133-61	POLES, HARDWARE, AND FRAMING	 11/01
Sheet 3 of 3	3PH XARM FRAMING 10FT	
Rev 08/01/2020	3PH DBL ALLEY ARM 10 FT	

	CU-REF	CU-DESCRIPTION	QTY	MU-REF
4/0-4/0 ANG	1240-05-26	TIES PREFM SIDE DBL 4/0	3	1133-61-01
	1240-05-50	TIES PREFM SIDE 4/0 NEUTRAL	1	1133-61-01
	1119-10-02	GRD WOOD POLE W/BUTT COIL #6 TO 4/0N	1	1133-61-01
	1163-12-20	DG DBL 1-7/16" W/ROD AND 1-3/8" GW	1	1133-61-01

	CU-REF	CU-DESCRIPTION	QTY	MU-REF
795-4/0 TAN	1240-04-30	TIES PREFM DBL 795	3	1133-61-01
	1240-05-50	TIES PREFM SIDE 4/0 NEUTRAL	1	1133-61-01
	1119-10-02	GRD WOOD POLE W/BUTT COIL #6 TO 4/0N	1	1133-61-01

	CU-REF	CU-DESCRIPTION	QTY	MU-REF
795-4/0 ANG	1240-05-30	TIES PREFM SIDE DBL 795	3	1133-61-01
	1240-05-50	TIES PREFM SIDE 4/0 NEUTRAL	1	1133-61-01
	1119-10-02	GRD WOOD POLE W/BUTT COIL #6 TO 4/0N	1	1133-61-01
	1163-12-20	DG DBL 1-7/16" W/ROD AND 1-3/8" GW	1	1133-61-01