

# 1099

## SIGNAGE

### CONTAINS

- 1099-09 POLE SIGNAGE
- 1099-10 PRIMARY RISER SIGNAGE
- 1099-12 PADMOUNT EQUIPMENT WARNING DECALS
- 1099-13 1PH PADMOUNT XFMR DECALS
- 1099-14 3PH PADMOUNT XFMR DECALS
- 1099-15A AIR INSULATED SWGR DECALS
- 1099-15B GAS INSULATED SWGR DECALS
- 1099-16 SECTIONALIZING CABINET DECALS
- 1099-17 POLE MOUNTED XFMR DECALS
- 1099-18A 36" PULLBOX TAGGING - 1PH & 3PH
- 1099-18B 18" SERVICE PULLBOX TAGGING - SINGLE & MULTIPLE
- 1099-19 MANHOLE TAGGING - 1PH

REV\_DATE:

04/01/26

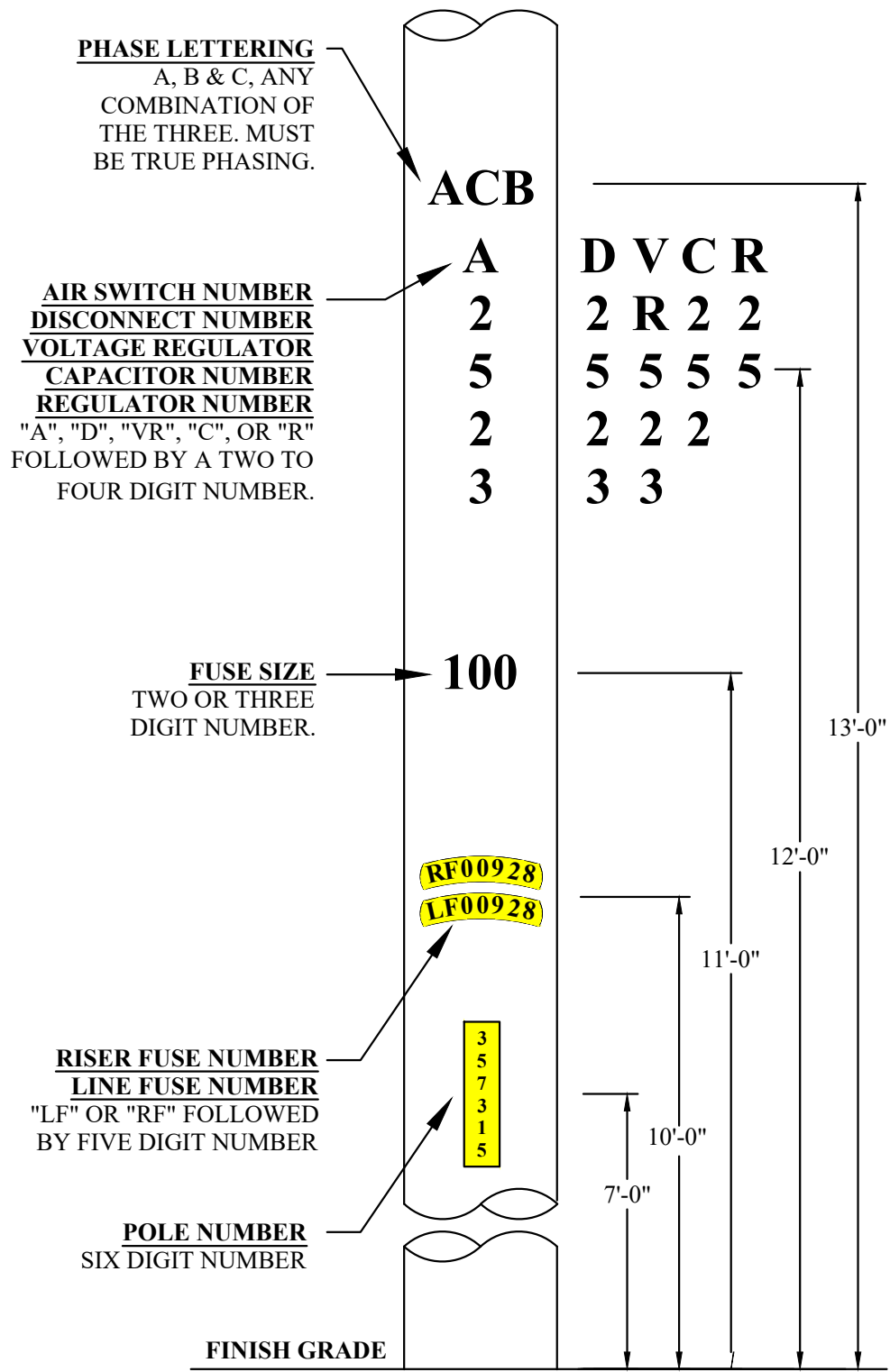

REV\_DATE:  
04/01/26

**OVERHEAD FED BY UNDERGROUND**  
LOCATED UNDER TERMINATIONS.  
(ITEM# 16642)

**NESC CLEARANCE REQUIRED**  
(AE ITEM# 22781)

**OVERHEAD FED BY UNDERGROUND**  
(ITEM# 16642)

**TWO WAY FEED**  
(AE ITEM# 16590)

**AIR SWITCH NUMBER DISCONNECT NUMBER**  
"A" OR "D" FOLLOWED BY FOUR DIGIT NUMBER.

**FUSE SIZE**  
TWO OR THREE DIGIT NUMBER.

**FUSE TYPE**  
ONE OR TWO DIGIT LETTER: "N", "KS", "X", OR "T".

**LINE FUSE NUMBER OR RISER FUSE NUMBER**  
"LF" OR "RF" FOLLOWED BY FIVE DIGIT NUMBER

**POLE NUMBER**  
SIX DIGIT NUMBER  
(ITEM# 24954)

FINISH GRADE

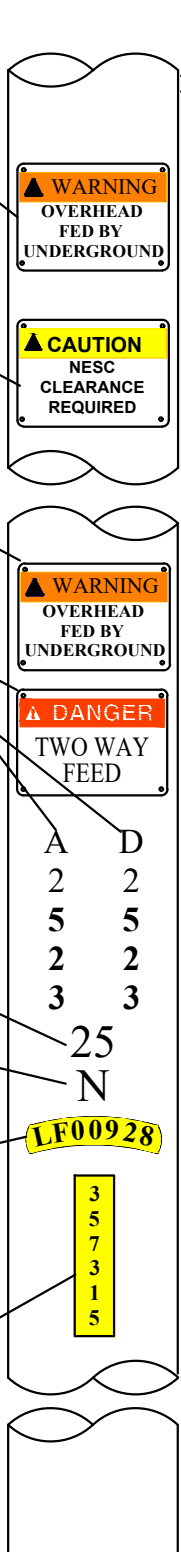

**PHASE LETTERING**  
ANY COMBINATION OF THE THREE LETTERS UNDER TERMINATION. MUST BE TRUE PHASING.

**CIRCUIT NUMBERING**  
ANY COMBINATION OF THE CIRCUIT NUMBER UNDER TERMINATION. SINGLE PHASE ONLY.

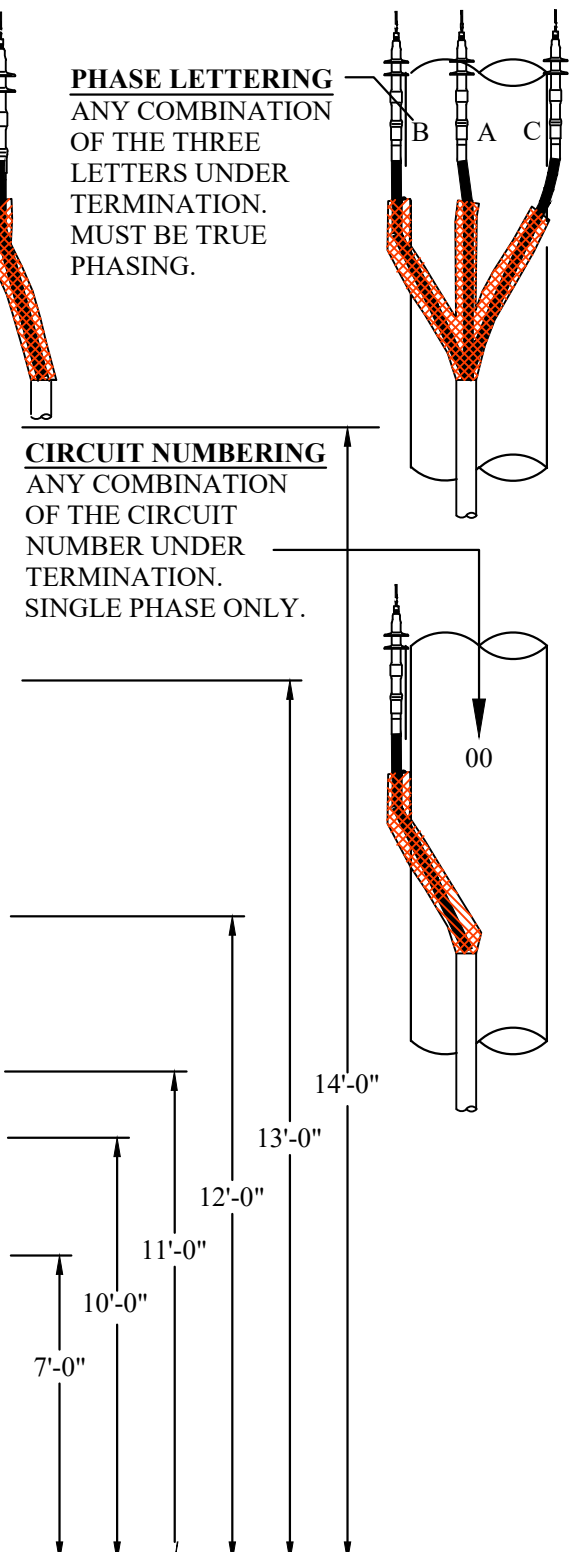

**PADMOUNT EQUIPMENT WARNING DECALS**

Black on orange background

White on blue background

10 1/2"

Black on orange background

10"

.25" Rcorners x4

**"3-IN-1 WARNING" DECAL**  
 DECAL, 3 IN 1 FOR ELECTROCUTION HAZ CLEARANCE 1 CALL  
 AE ITEM # 17863

white on red background

10.75"

Date Stamp

.6"

.37"

.48"

.176"

1/4" round corners

.875"

5.25"

All other graphics print black on white background.

**DANGER DECAL FOR PADMOUNT EQUIPMENT (INTERNAL)**  
 DECAL, DANGER FOR PD MT EQUIP INTERNAL  
 AE ITEM # 25016

REV\_DATE:  
04/01/26

**1PH PADMOUNT XFMR - EXTERIOR**

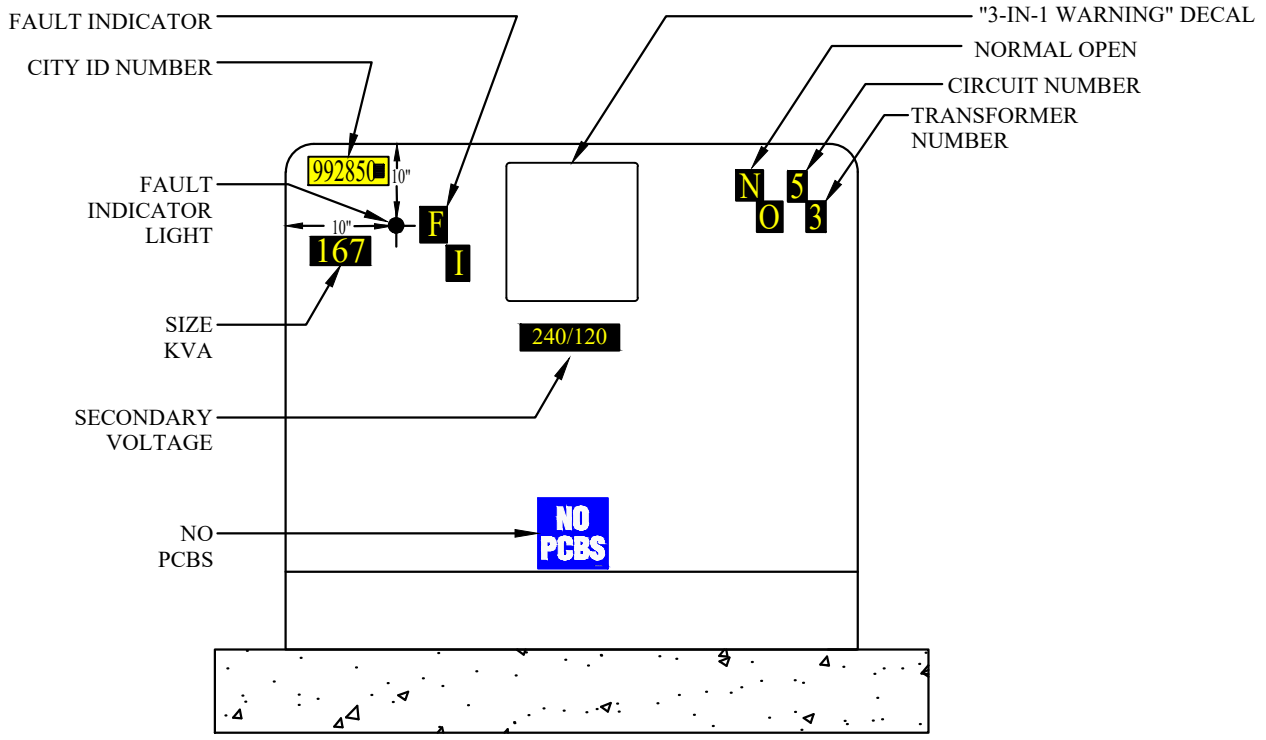

**1PH PADMOUNT XFMR - INTERIOR**

X/X - TRANSFORMER NUMBER  
RFXXX - RISER FUSE  
ADDRESS - HOME ADDRESS/LOCATION

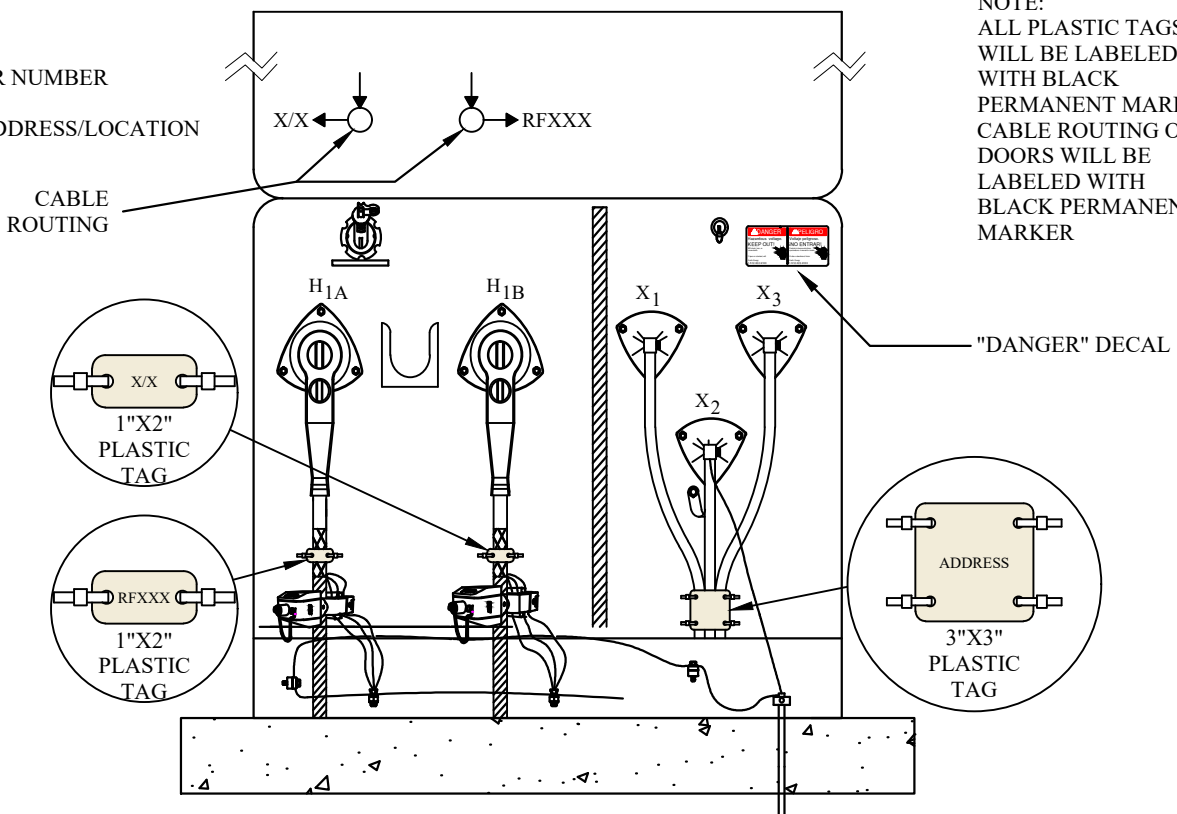

**3PH PADMOUNT XFMR - EXTERIOR**

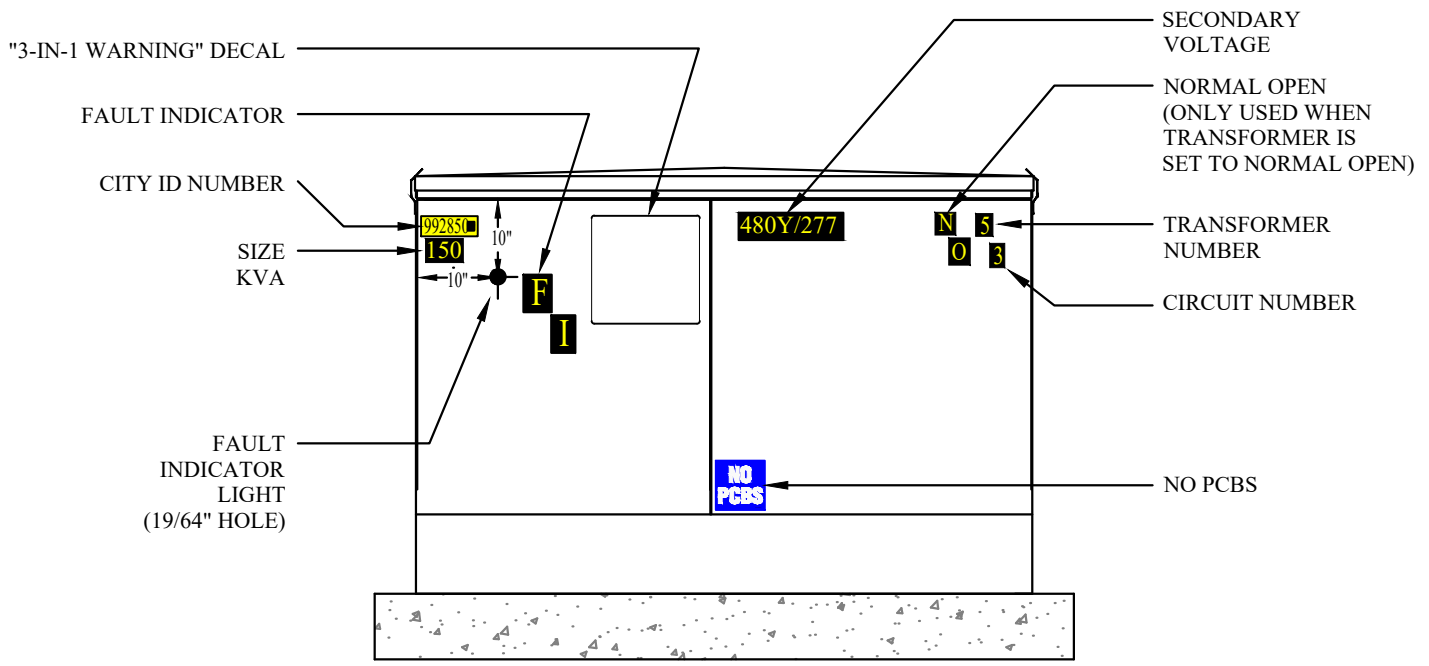

**3PH PADMOUNT XFMR - INTERIOR**

X/X - TRANSFORMER NUMBER  
 RFXXX - RISER FUSE  
 ADDRESS - HOME ADDRESS/LOCATION

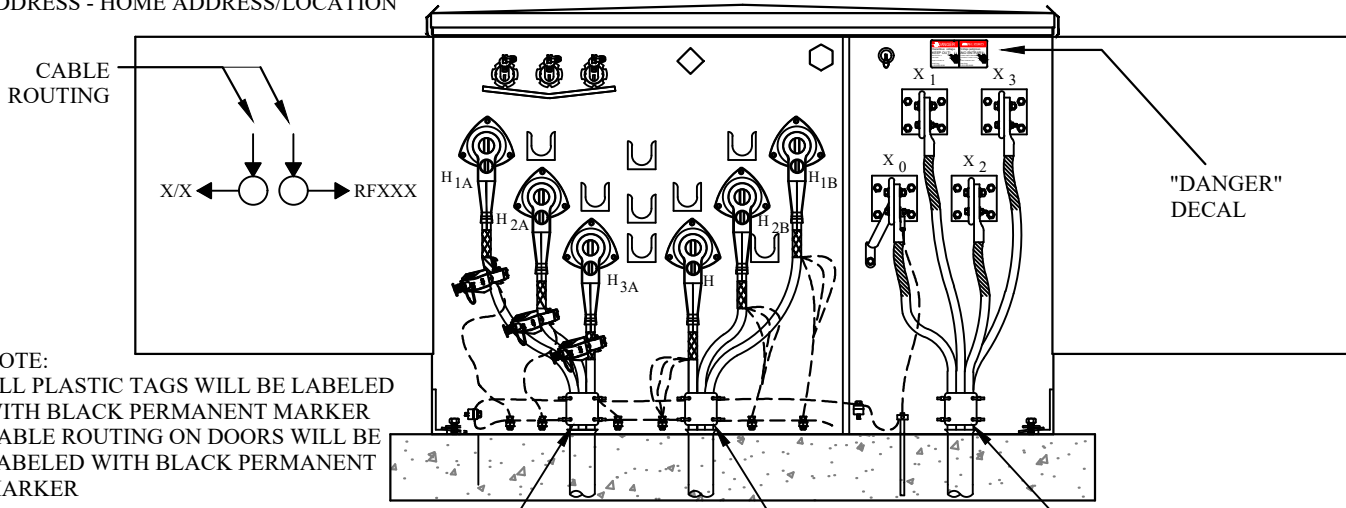

NOTE:  
 ALL PLASTIC TAGS WILL BE LABELED WITH BLACK PERMANENT MARKER  
 CABLE ROUTING ON DOORS WILL BE LABELED WITH BLACK PERMANENT MARKER

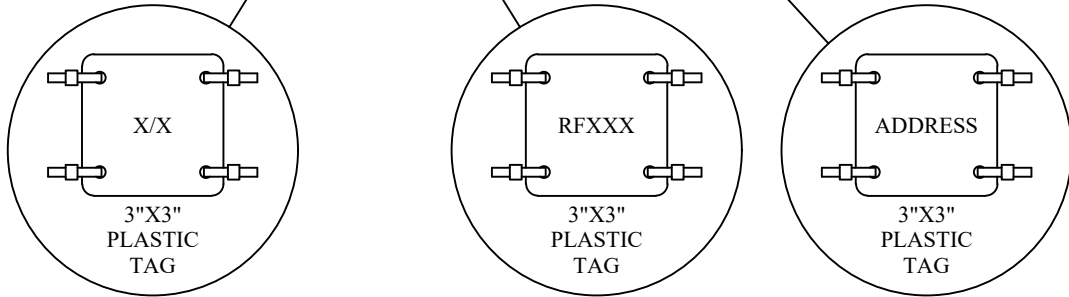

REV\_DATE:  
04/01/26

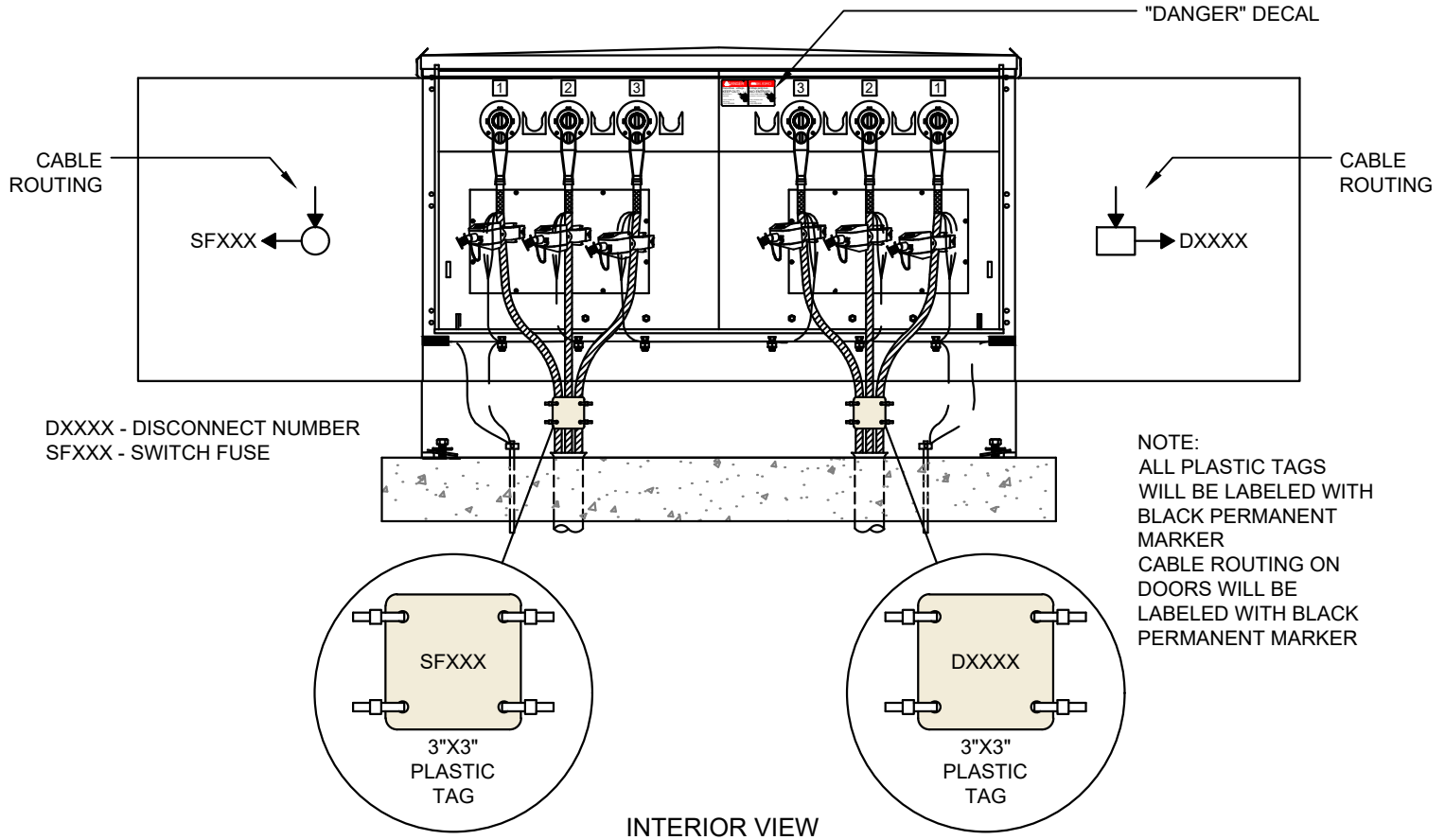
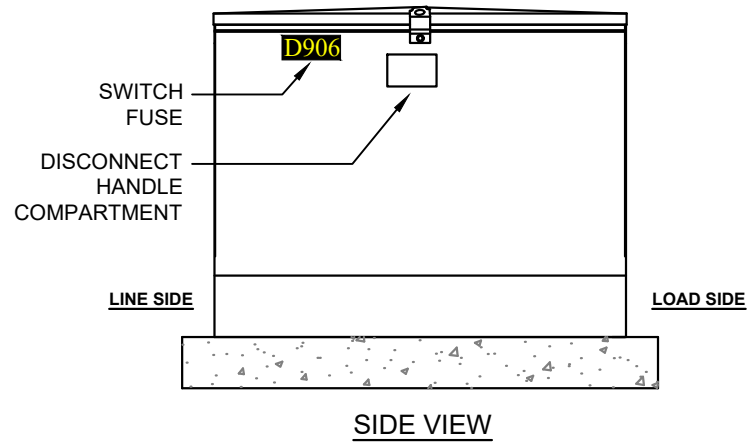
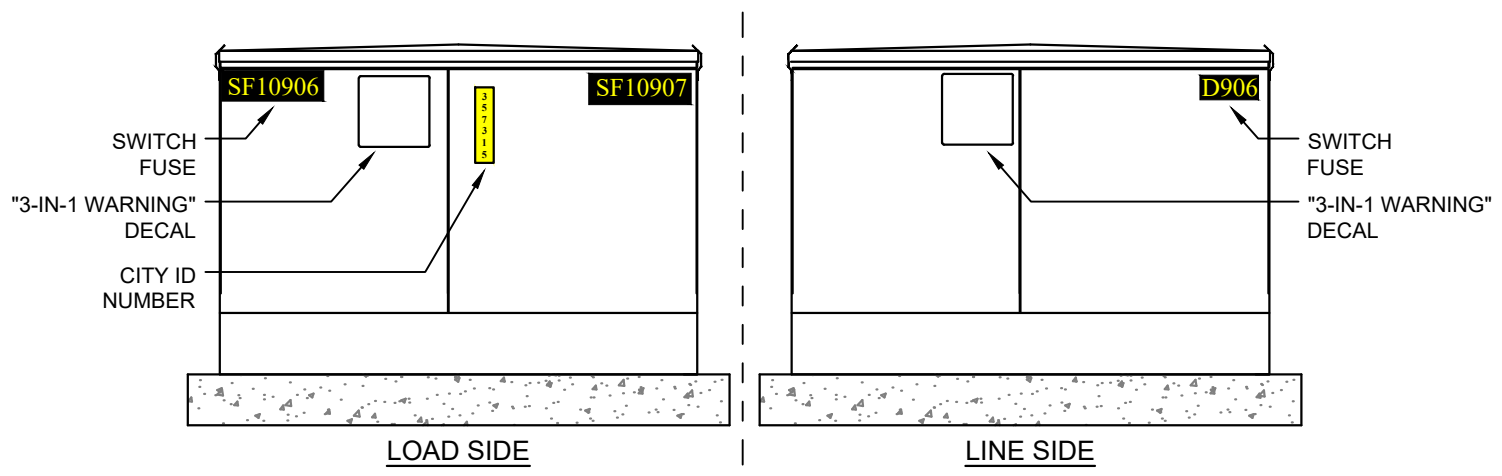

REV\_DATE:  
04/01/26

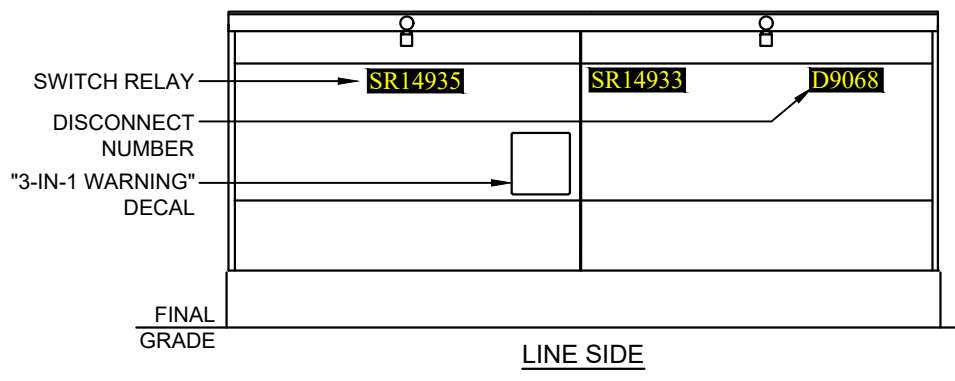
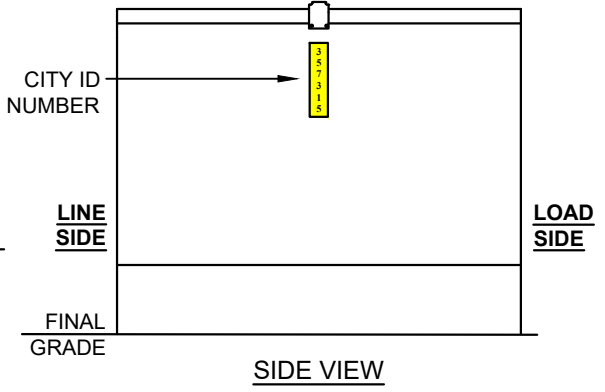
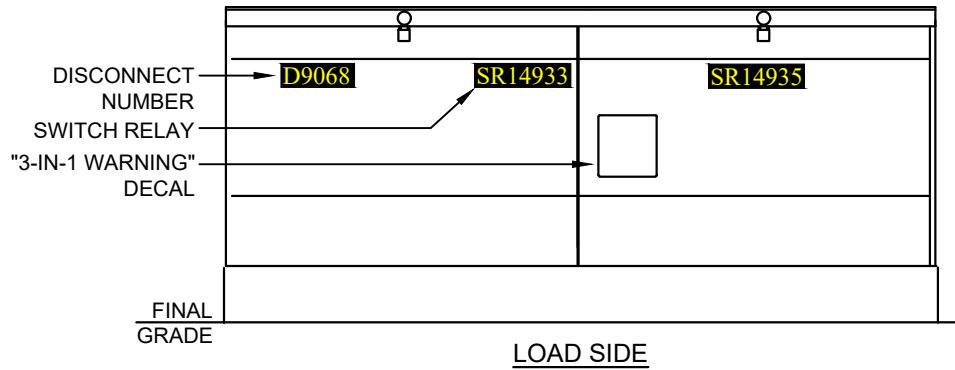

NOTE:  
ALL PLASTIC TAGS  
WILL BE LABELED WITH  
BLACK PERMANENT  
MARKER  
CABLE ROUTING ON  
DOORS WILL BE  
LABELED WITH BLACK  
PERMANENT MARKER

X-X - XFMR NUMBER  
RFXXX - RISER FUSE  
DXXXX - DISCONNECT  
SFXXX - SWITCH FUSE

SWITCH RELAY  
2"  
REFLECTIVE  
STICKERS

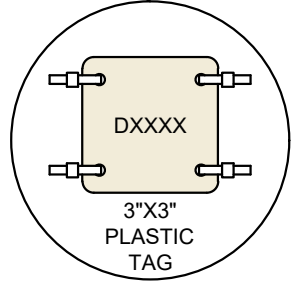
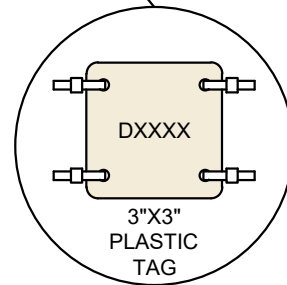
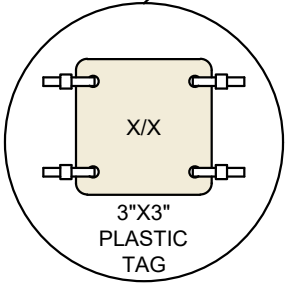
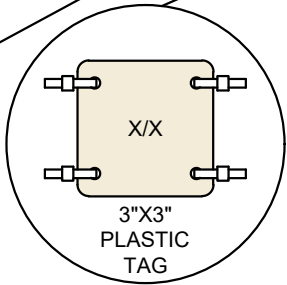
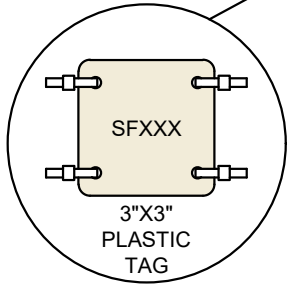
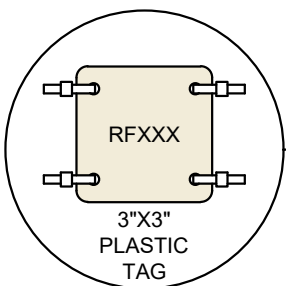
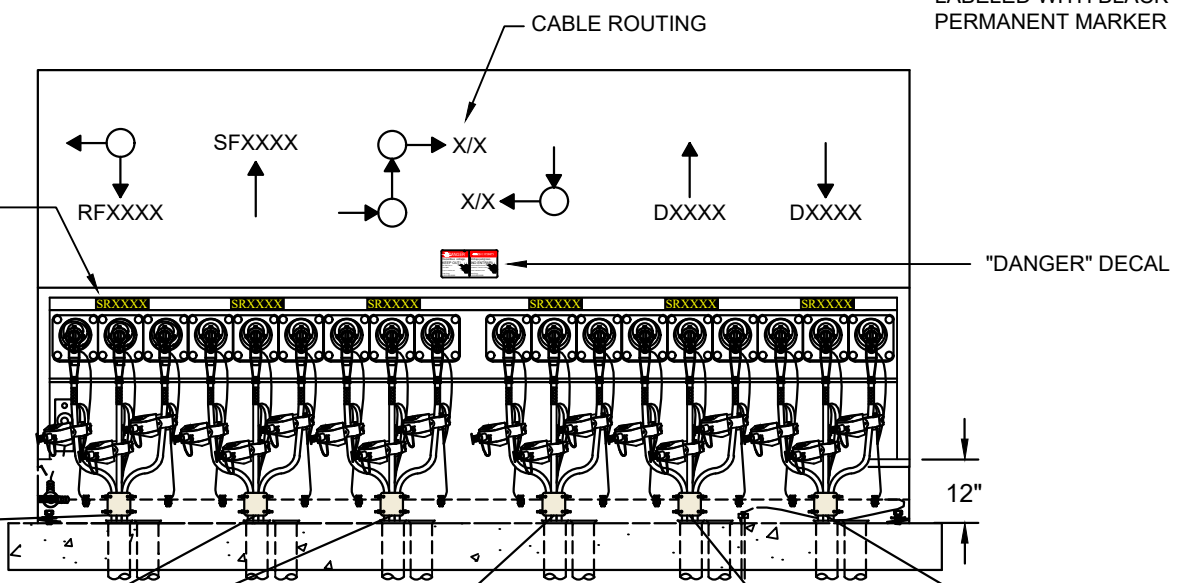

**INTERIOR VIEW**

**SECTIONALIZING CABINET - EXTERIOR**

**CURCUIT NUMBER**  
 "CKT" FOLLOWED BY A  
 ONE, TWO, OR THREE  
 DIGIT NUMBER.

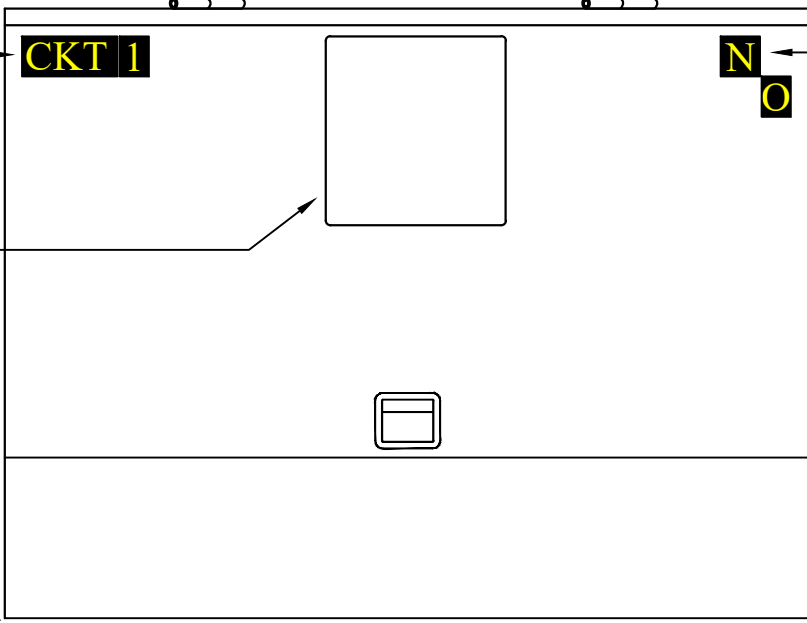

**"3-IN-1 WARNING"**  
DECAL

**NORMALY OPEN**  
 ONLY USED WHEN  
 SECTIONALIZING  
 CABINET IS SET TO  
 NORMALY OPEN.

**SECTIONALIZING CABINET - INTERIOR**

**"DANGER" DECAL**

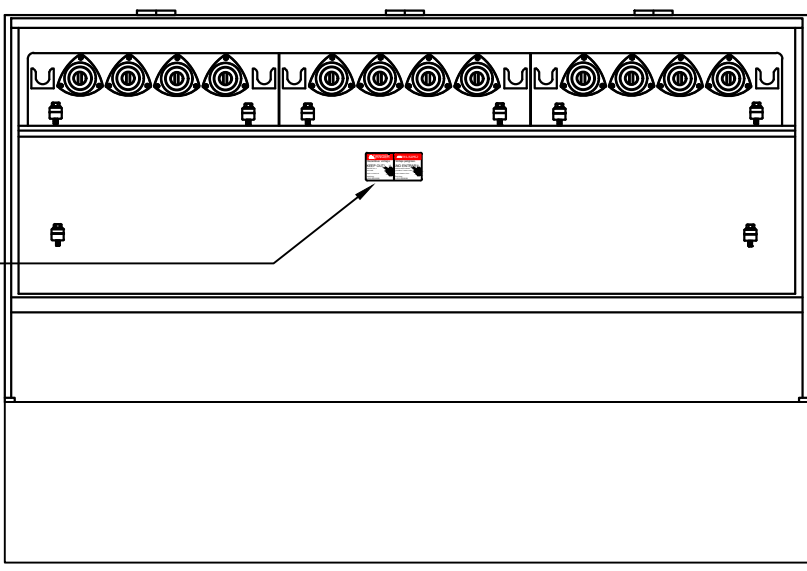

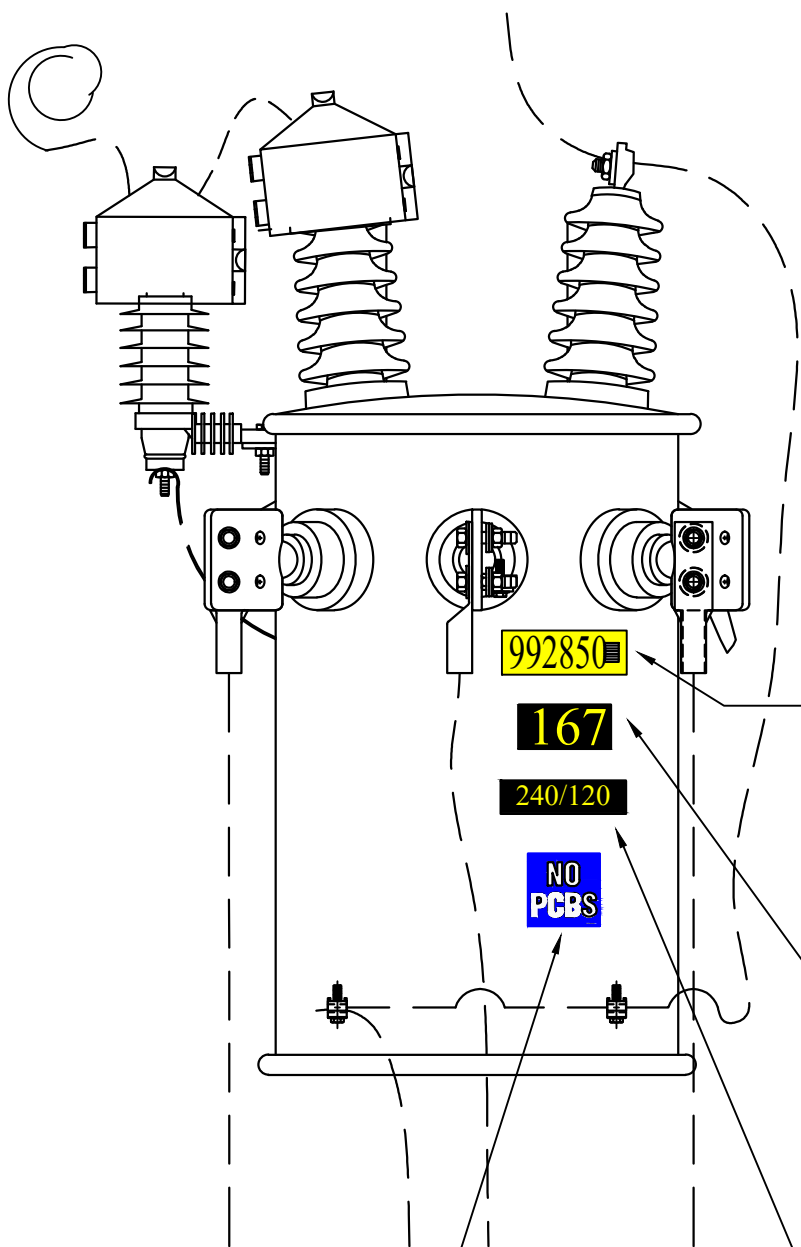

**CITY ID NUMBER**  
 LOCATED AT THE TOP OF THE TRANSFORMER ON THE RIGHT-HAND SIDE WHERE IT IS VISIBLE FROM THE STREET/YARD.

**SIZE KVA**  
 LOCATED IN THE CENTER ABOVE THE SECONDARY VOLTAGE STICKER WHERE IT IS VISIBLE FROM THE STREET/YARD.

**SECONDARY VOLTAGE:**  
 LOCATED IN THE CENTER ABOVE THE PCB STICKER WHERE IT IS VISIBLE FROM THE STREET/YARD.

**NO PCBs**  
 LOCATED IN THE CENTER OF THE TRANSFORMER UNDER THE SECONDARY VOLTAGE STICKER WHERE IT IS VISIBLE FROM THE STREET/YARD.

**36" PULLBOX TAGGING - 1PH & 3PH**

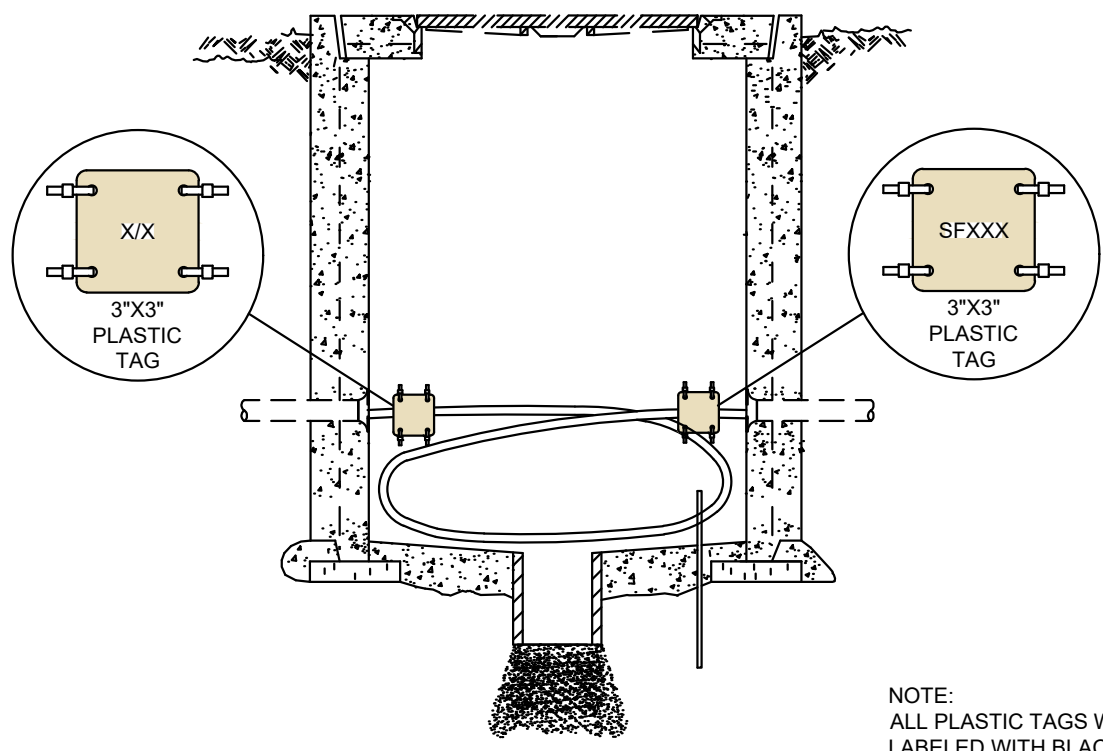

36" PULLBOX  
SINGLE PHASE URD (PRIMARY)

NOTE:  
ALL PLASTIC TAGS WILL BE  
LABELED WITH BLACK  
PERMANENT MARKER

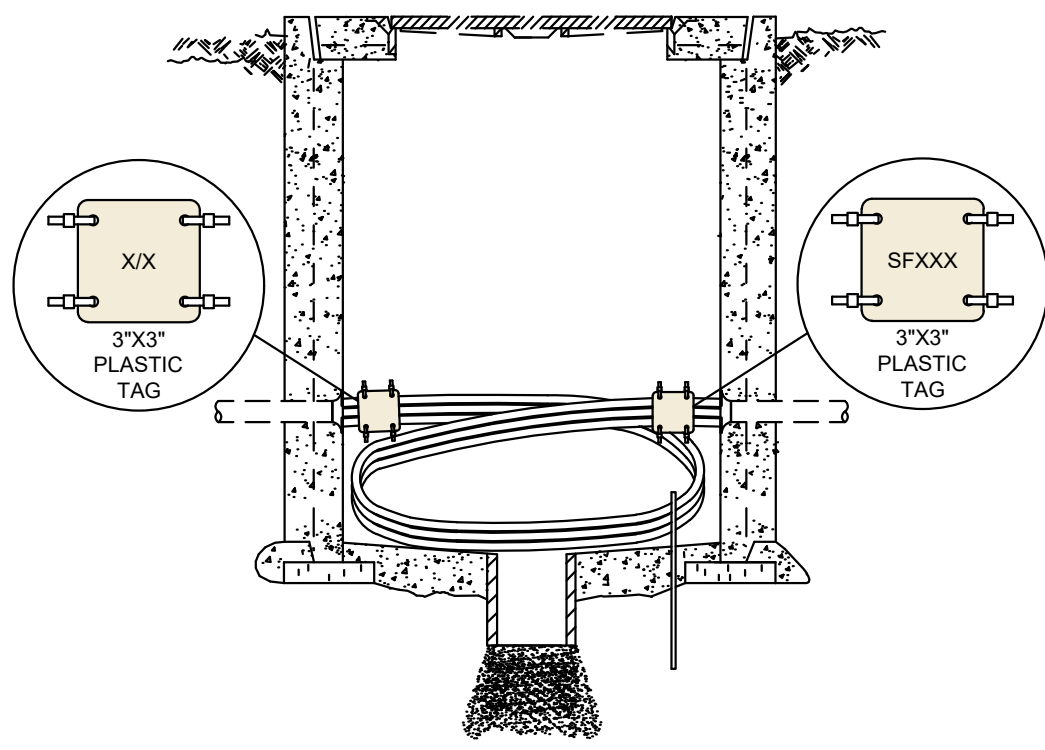

36" PULLBOX  
THREE PHASE URD (PRIMARY)

REV\_DATE:

04/01/26

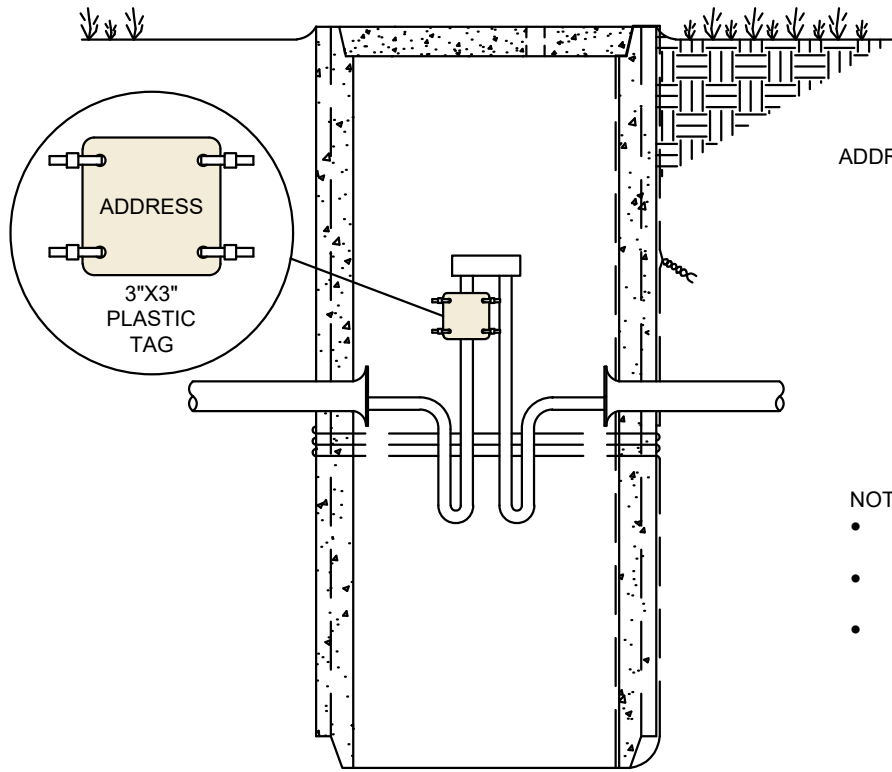

ADDRESS - HOME ADDRESS OR LOCATION

18" SERVICE BOX  
SINGLE SERVICE

NOTES:

- ALL PLASTIC TAGS WILL BE LABELED WITH BLACK PERMANENT MARKER.
- INSTALL TAG ON NEUTRAL WIRE OF SERVICE, BELOW THE CONNECTOR.
- 3"X3" PLASTIC TAG FOR SERVICE WIRE 600V OR LESS.

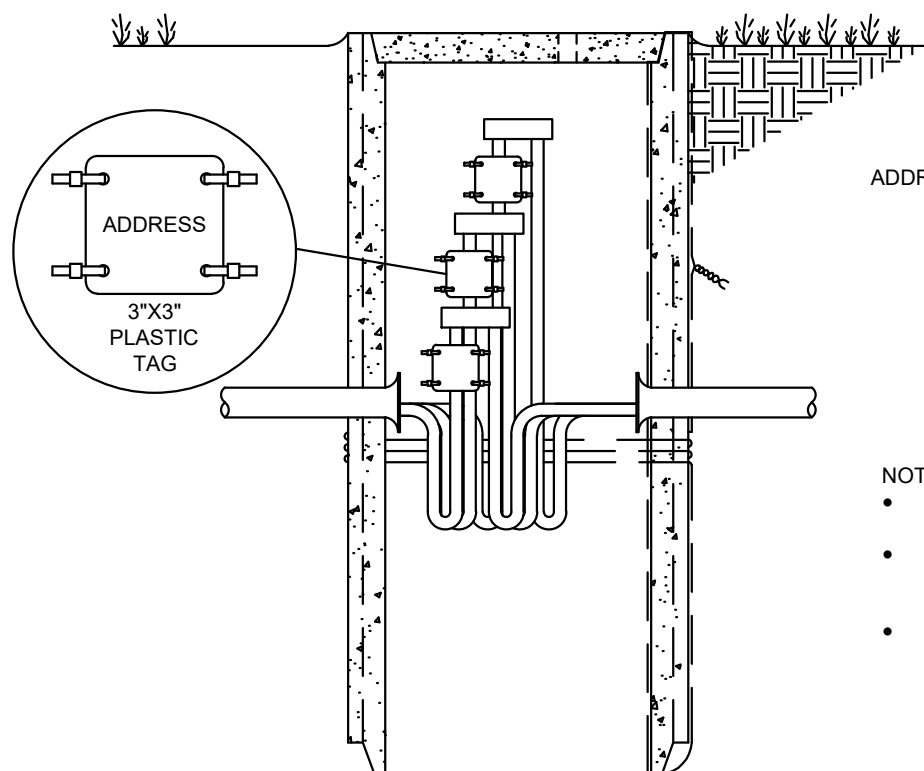

ADDRESS - HOME ADDRESS OR LOCATION

18" SERVICE BOX  
MULTIPLE SERVICE

NOTES:

- ALL PLASTIC TAGS WILL BE LABELED WITH BLACK PERMANENT MARKER.
- INSTALL TAG ON NEUTRAL WIRE OF SERVICE, BELOW THE CONNECTOR, FOR EACH SERVICE.
- 3"X3" PLASTIC TAG FOR SERVICE WIRE 600V OR LESS.

REV\_DATE:  
04/01/26

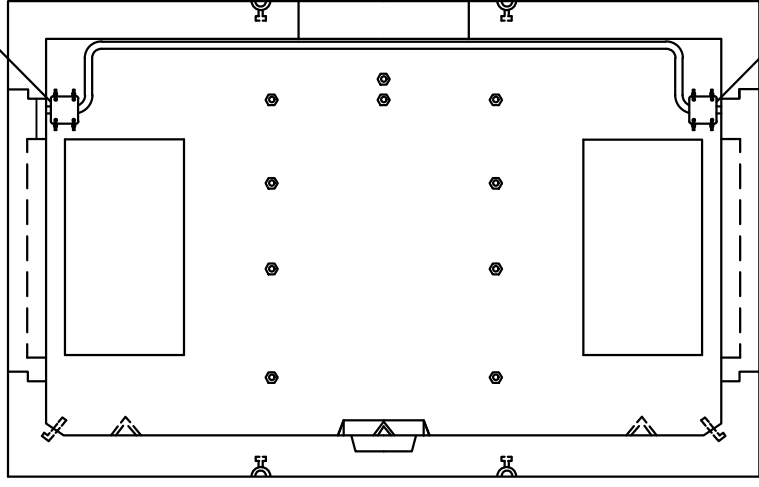
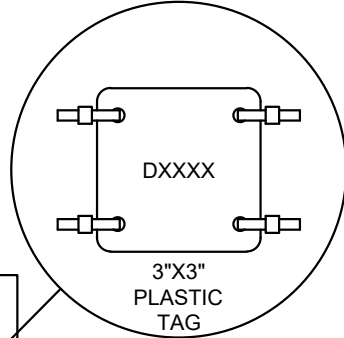
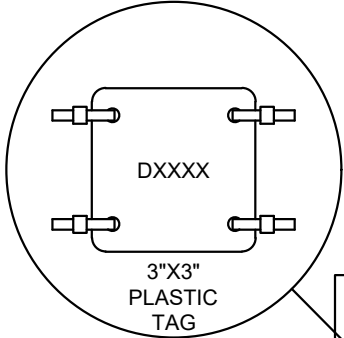

MANHOLE DETAIL  
PLAN VIEW

NOTES:  
ALL PLASTIC TAGS WILL BE LABELED WITH BLACK PERMANENT MARKER.